

Display Elektronik GmbH

DATA SHEET

TFT- MODULE

DEM 800600G TMH-PW-N

10,4" TFT

17.02.2015

Revise Records

Rev.	Date	Contents	Written	Approved
0	17.05.2012	Preliminary Specification	MH	
1	04.07.2014	Updated brightness	MH	
2	17.02.2015	Update DC Electrical Characteristics	MH	

Special Notes

Note1.	
Note2.	
Note3.	
Note4.	
Note5.	

Contents

1.	General Description and Features	4
1.1	Features	4
1.2	LCD Module	4
2.	Mechanical Information	4
3.	Electrical Specifications	5
3.1	Absolute Max. Ratings	5
3.2	LVDS Switching Characteristics	10
4.	Optical Characteristics	12
4.1	Optical characteristic of the LCD	12
5.	I/O Terminal	14
5.1	Pin Assignment (CN1)	14
5.2	Back-light	15
5.3	Block Diagram	16
6.	Displayed Color and Input Data	17
7.	Reliability Condition	18
8.	Dimensional Outlines	19
9.	Incoming Inspection Standards	20

1. General Description and Features

DEM 800600G TMH-PW-N is a transmissive type color active matrix TFT (Thin Film Transistor) liquid crystal display (LCD) that uses amorphous silicon TFT as a switching device. This model is composed of a TFT-LCD module, a receiver circuit, and a back-light unit. Graphics and texts can be displayed on a SVGA 800 (W) x 3 x 600 (H) dots (4:3 aspect ratio) with 262,144 colors by supplying 18 bits data signal (6bits/each color). The following table described the features of DEM 800600G TMH-PW-N.

1.1 Features

- Transmissive and LED Backlight with 42 LEDs.
- TN (Twisted Nematic) mode.
- LVDS Receiver 18 bit Interface.
- LED Backlight Dimming control

1.2 LCD Module

Item	Specification	Unit
Screen Size	10.4 inches	Diagonal
Display Resolution	800 (H) x 600 (V)	Pixel
Active Area	211.2 (H) x 158.4 (V)	mm
Outline Dimension	243 (H) x 185.6 (V) x 7.3 (T)	mm
Display Mode	Normally white mode/ Transmissive	--
Surface Treatment	Anti-glare(AG)	--
Pixel Arrangement	R,G,B Vertical Stripe	--
Pixel Size	192 x 180.5	um
Display Color	262k	--
Viewing Direction	6 o'clock	--
Input Interface	LVDS Receiver 18 bit Interface	--

2. Mechanical Information

Item	Min.	Typ.	Max.	Unit	Note
Module Size	Horizontal (H)	--	243	--	mm
	Vertical (V)	--	185.6	--	mm
	Thickness (T)	--	7.3	--	mm
Weight	--	371	--	g	--

Note (1) Not Include Component. Refer to the Outline Dimension Drawing as attached.

3. Electrical Specifications**3.1 Absolute Max. Ratings**

3.1.1 Absolute Ratings of Environment

If the operating condition exceeds the following absolute maximum ratings, the TFT LCD module may be damaged permanently.

(Ta=25±2°C, GND=0)

Item	Symbol	Min.	Max.	Unit	Note
Storage temperature	T _{STG}	-30	80	°C	(1)
Operating temperature	T _{OPR}	-20	70	°C	(1,2,3)

Note (1) 95 % RH Max. (40 °C ≥ Ta). Maximum wet-bulb temperature at 39 °C or less. (Ta > 40 °C) No condensation.

Note (2) In case of below 0°, the response time of liquid crystal (LC) becomes slower and the color of panel becomes darker than normal one. Level of retardation depends on temperature, because of LC's character

Note (3) Only operation is guaranteed at operating temperature. Contrast, response time, another display quality are evaluated at +25°C.

3.1.2 Electrical Absolute Maximum Ratings

(V_{SS}=GND=0)

Parameter	Symbol	Min.	Max.	Unit	Remark
Power supply Logic voltage	VDD	-0.3	4.0	V	
Power supply LED voltage	VCC	-0.3	32	V	
Permissive input ripple voltage	V _{RF}	--	100	mVp-p	VDD=+3.3V

Display On/Off Sequence :

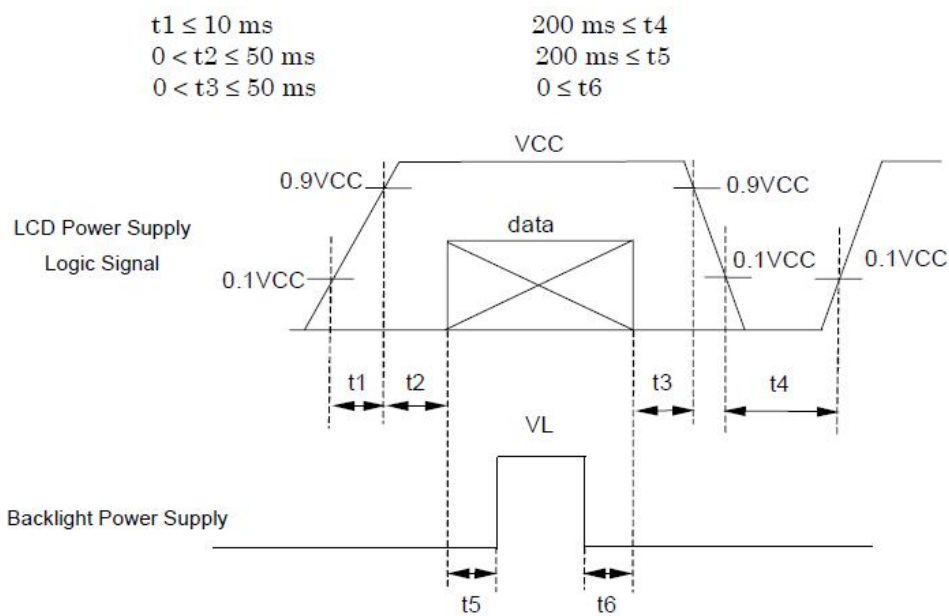

3.1.3 DC Electrical Characteristics of the TFT LCD

(Ta=25±2°C, GND=0)

Item	Symbol	Min.	Typ.	Max.	Unit	Remark	
Power supply Logic Voltage	VDD	3.0	3.3	3.6	V		
Power supply LED Voltage	VCC	-	12	-	V		
Input Voltage for logic	H Level	VIH	0.7xVDD	-	VDD	V	
	L Level	VIL	0	-	0.3xVDD	V	
Power Supply current	IDD	-	170	200	mA	Note 1	
Power Supply current	ICC	-	260	300	mA		
LED Life time	-	(40000)	-	-	Hr	Note 2	

Note1: fv =60Hz , Ta=25°C , Display pattern : Black pattern

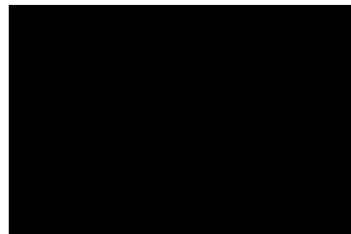

Note2: The environmental conducted under ambient air flow ,at Ta=25±2°C,60%RH±5%

3.1.4 AC Timing Condition

Signal	Parameter	Symbol	Min.	Typ.	Max.	Unit.	Remark
DCLK	CLK frequency	fclk	-	40	50	MHz	
	CLK period	tclk	20	25	-	ns	
	CLK pulse duty	tcwh	40	50	60	%	
Horizontal Timing	One Horizontal Line	th	862	1056	1200	DCLK	
	Horizontal Display Area	thd	-	800	-	DCLK	
	HS pulse width	thpw	1	-	40	DCLK	
	HS Back Porch	thb	46	46	46	DCLK	blanking
	HS Front Porch	thfp	16	210	354	DCLK	
Vertical Timing	VS period time	tv	624	635	700	TH	
	Vertical Display Area	tvd	-	600	-	TH	
	VS pulse width	tvpw	1	-	20	TH	
	VS Back Porch	tvb	23	23	23	TH	blanking
	VS Front Porch	tvfp	1	12	77	TH	

3.1.5 Clock and Data input waveforms

Parameter	Symbol	Min.	Typ.	Max.	Unit.	Remark
HS setup time	Thst	8	-	-	ns	
HS hold time	Thhd	8	-	-	ns	
VS setup time	Tvst	8	-	-	ns	
VS hold time	Tvhd	8	-	-	ns	
Data setup time	Tdsu	8	-	-	ns	
Data hold time	Tdhd	8	-	-	ns	
DE setup time	Tesu	8	-	-	ns	
DE hold time	Tehd	8	-	-	ns	
CLKIN cycle time	Tcph	20	-	-	ns	

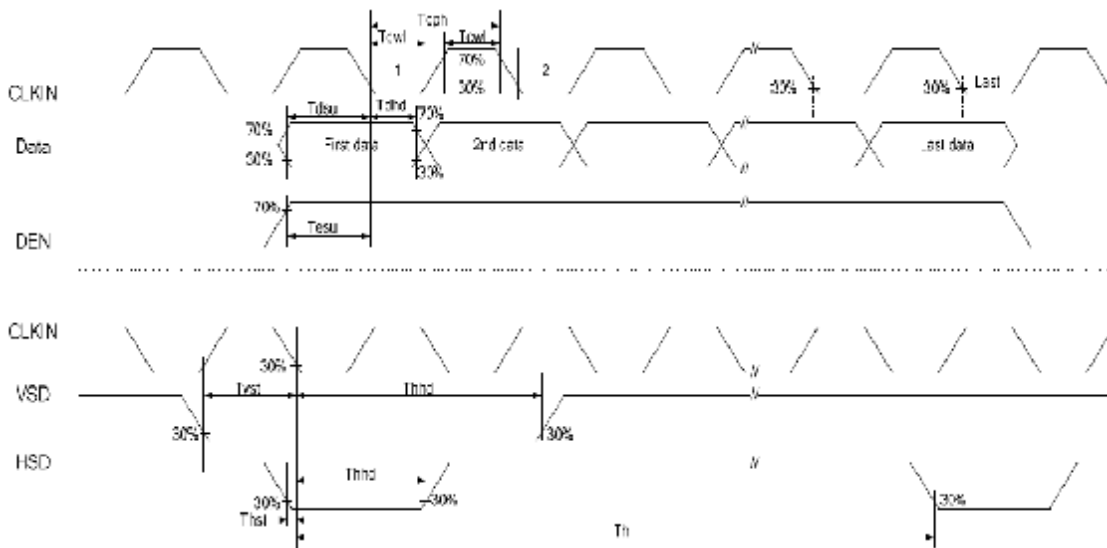

3.1.6 Timing Characteristic
 3.1.6.1 Horizontal Timing

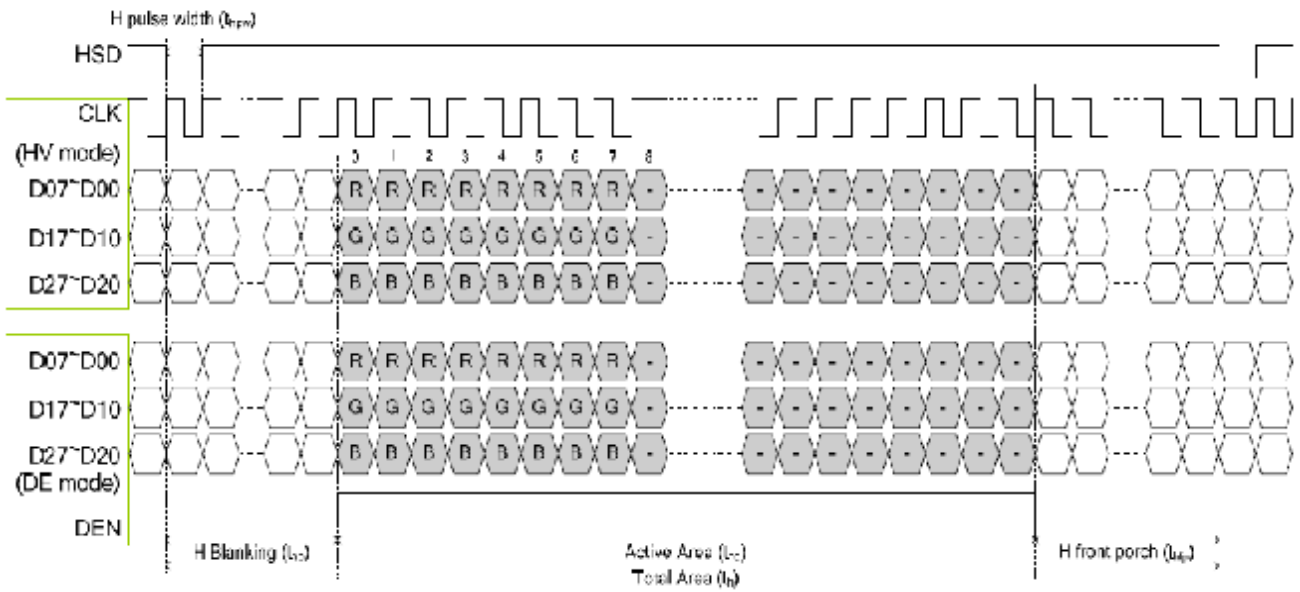

3.1.6.2 Vertical Timing

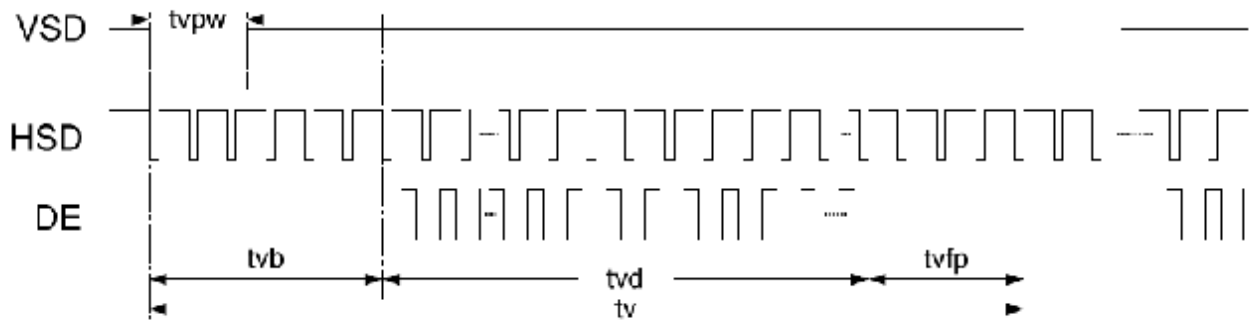

3.2 LVDS Switching Characteristics

3.2.1 LVDS Timing Condition

Symbol	Parameter		Min.	Typ.	Max.	Unit.	Note
tRCP	CLK OUT Period	VDD = 3.0 - 3.6V	11.76	T	50.0	ns	
		VDD = 2.5 - 3.6V	14.28	T	50.0	ns	
tRCH	CLK OUT High Time		-	4T/7	-	ns	
tRCL	CLK OUT Low Time		-	3T/7	-	ns	
tRCD	RCLK +/- to CLK OUT Delay		-	5T/7	-	ns	
tRS	TTL Data Setup to CLK OUT		0.35T-0.3	-	-	ns	
tRH	TTL Data Hold from CLK OUT		0.45T-1.6	-	-	ns	
tTLH	TTL Low to High Transition Time		-	2.0	3.0	ns	
tTHL	TTL High to Low Transition Time		-	1.8	3.0	ns	
tRIP1	Input Data Position0 (T = 11.76ns)		-0.4	0.0	0.4	ns	
tRIP0	Input Data Position1 (T = 11.76ns)		T/7-0.4	T/7	T/7+0.4	ns	
tRIP6	Input Data Position2 (T = 11.76ns)		2T/7-0.4	2T/7	2T/7+0.4	ns	
tRIP5	Input Data Position3 (T = 11.76ns)		3T/7-0.4	3T/7	3T/7+0.4	ns	
tRIP4	Input Data Position4 (T = 11.76ns)		4T/7-0.4	4T/7	4T/7+0.4	ns	
tRIP3	Input Data Position5 (T = 11.76ns)		5T/7-0.4	5T/7	5T/7+0.4	ns	
tRIP2	Input Data Position6 (T = 11.76ns)		6T/7-0.4	6T/7	6T/7+0.4	ns	
tRPLL	Phase Lock Loop Set				10.0	ms	

3.2.2 LVDS AC Timing

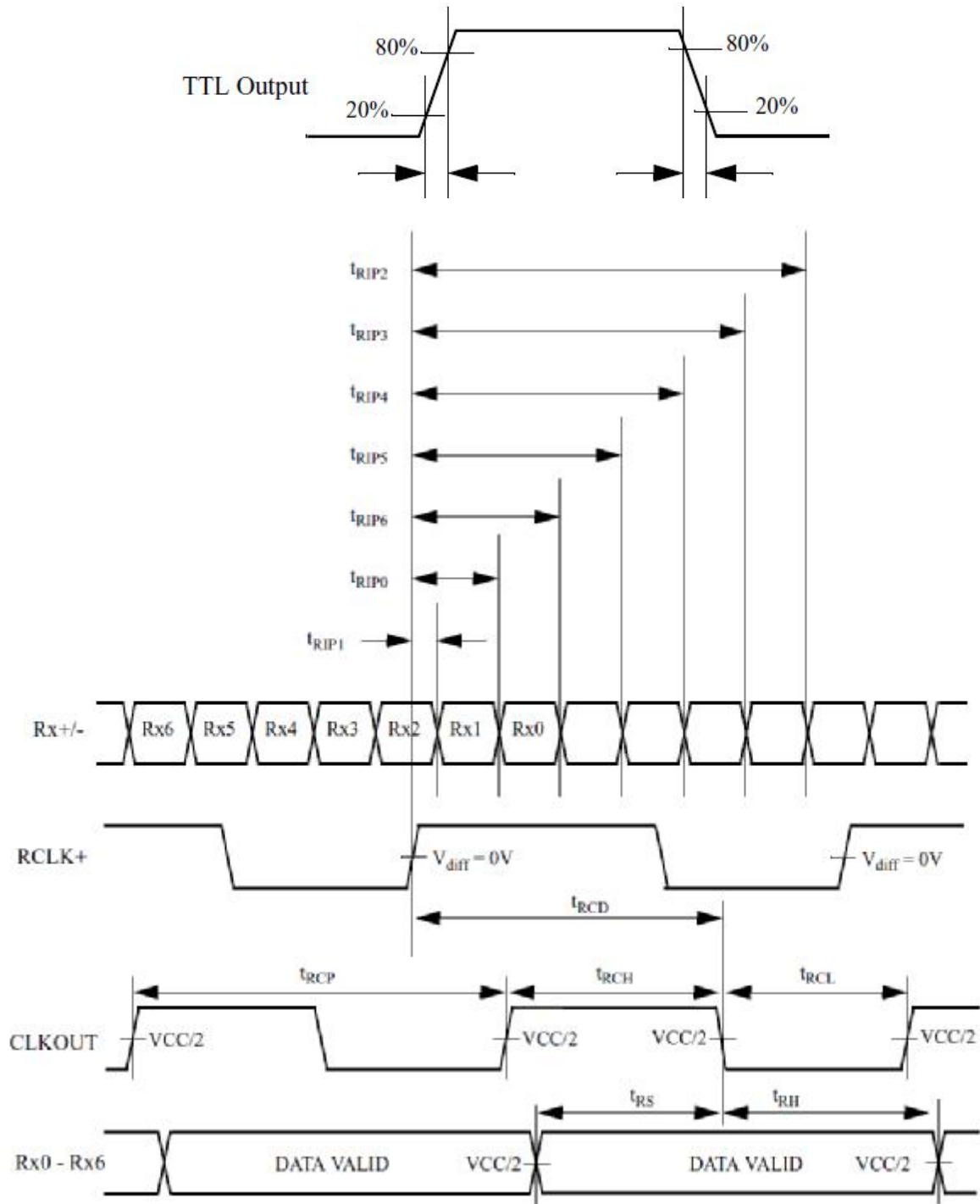

4. Optical Characteristics

4.1 Optical characteristic of the LCD

The following items are measured under stable conditions. The optical characteristics should be measured in a dark room or equivalent state with the methods.

Measuring equipment: BM-7A

Item	Symbol	Condition	Min	Type	Max	Unit	Note	
Brightness	B		(500)	(600)	--	cd/m ²		
Response time	T _r	θ=0°	-	5	10	ms	.	
	T _f		--	15	20	ms		
Contrast ratio	CR	At optimized viewing angle	(300)	(500)	--	--		
Luminance Uniformity	ΔL		70	75		%		
Color Chromaticity (CIE 1931)	White	W _x	θ=0° Normal Viewing Angle	(0.270)	(0.320)	(0.370)	--	BM-7A
		W _y		(0.300)	(0.350)	(0.400)		
Viewing Angle (6H)	Hor.	θ _R	CR≥10	60	70	--	Degree	
		θ _L		60	70	--		
	Ver.	θ _U		40	50	--		
		θ _D		50	60	--		

a. Test equipment setup

After stabilizing and leaving the panel alone shall be warmed up for the stable operation of LCM, the measurement should be executed. Measurement should be executed in a stable, windless, and dark room. Optical specifications are measured by Topcon BM-7A(fast) with a viewing angle of 2° at a distance of 50cm and normal direction.

b. Definition of response time: Tr and Tf

The response time is defined as the following figure and shall be measured by switching the input signal for "black" and "white".

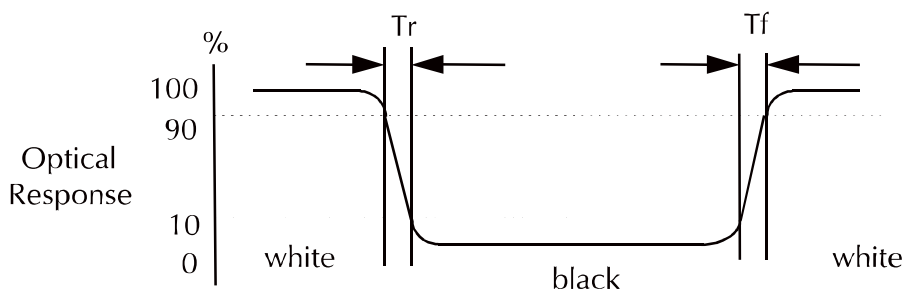

c. Definition of contrast ratio:

Brightness measured when LCD is at "white state"

$$\text{Contrast Ratio (CR)} = \frac{\text{Brightness measured when LCD is at "white state"}}{\text{Brightness measured when LCD is at "black state"}}$$

Brightness measured when LCD is at "black state"

- d. Measured at the center area of the panel when all the input terminals of LCD panel are electrically opened.
- e. View Angle

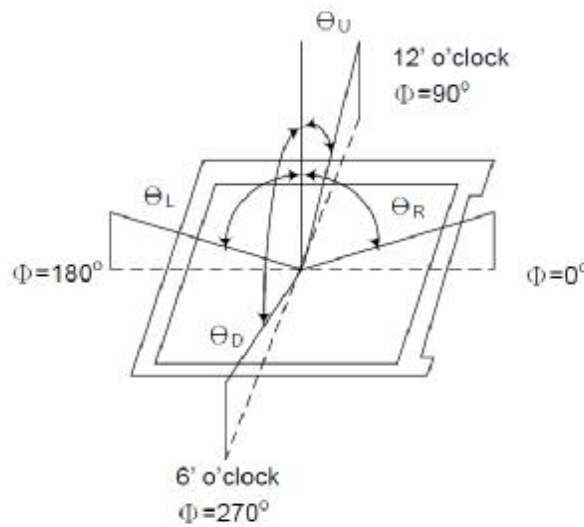

- f. Definition of Luminance of White: Luminance of white at the center points

Light Source of Back-Light Unit	LED Type
---------------------------------	----------

- g. Definition of White Uniformity

$$\text{White Uniformity} = \frac{\text{Min. luminance of white among 9-points}}{\text{Max. luminance of white among 9-points}} \times 100\%$$

5. I/O Terminal

5.1 Pin Assignment (CN1 connector part No: MSB24013P20HA or equivalent.)

Pin No.	Symbol	I/O	Function	Remark
1	VDD	P	Power Supply Logic voltage +3.3V	
2	VDD	P	Power Supply Logic voltage +3.3V	
3	GND	P	Ground	
4	GND	P	Ground	
5	RxIN0-	I	Negative LVDS differential data input	
6	RxIN0+	I	Positive LVDS differential data input	
7	GND	P	Ground	
8	RxIN1-	I	Negative LVDS differential data input	
9	RxIN1+	I	Positive LVDS differential data input	
10	GND	P	Ground	
11	RxIN2-	I	Negative LVDS differential data input	
12	RxIN2+	I	Positive LVDS differential data input	
13	GND	P	Ground	
14	RxCLKIN-	I	Negative LVDS differential clock input	
15	RxCLKIN+	I	Positive LVDS differential clock input	
16	GND	P	Ground	
17	NC	-	No Connect	
18	NC	-	No Connect	
19	NC	-	No Connect	
20	NC	-	No Connect	

I: Input, O: Output, P: Power

Notes:

- 1) GND Pin must ground contact, can not be floating.

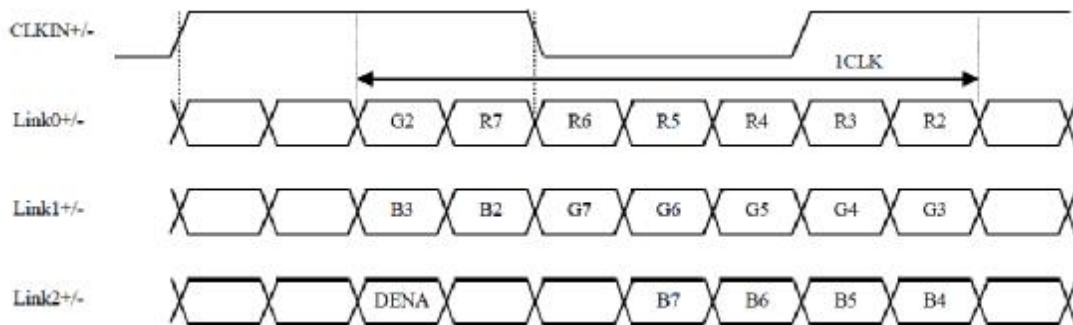

5.2 Backlight (CN2:ENTERY 3808K-F05N-03L or Equivalent)

Pin No.	Symbol	I/O	Function	Remark
1	VCC	P	Power Supply Logic voltage +12V	
2	GND	P	Ground	
3	ON/OFF	P	Backlight ON/OFF	
4	Dimming	P	Adjust brightness	
5	GND	P	Ground	

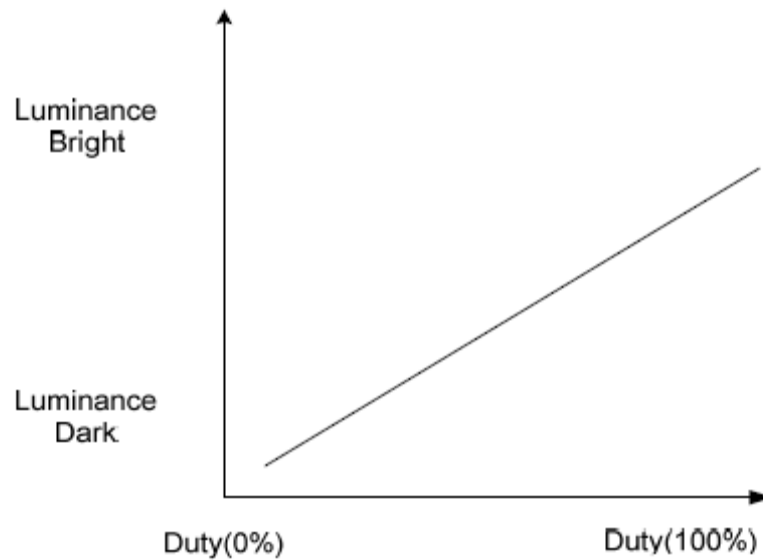

Note 2: ADJ signal=0~3.3V, Operating frequency:20KHz



5.3 Block Diagram

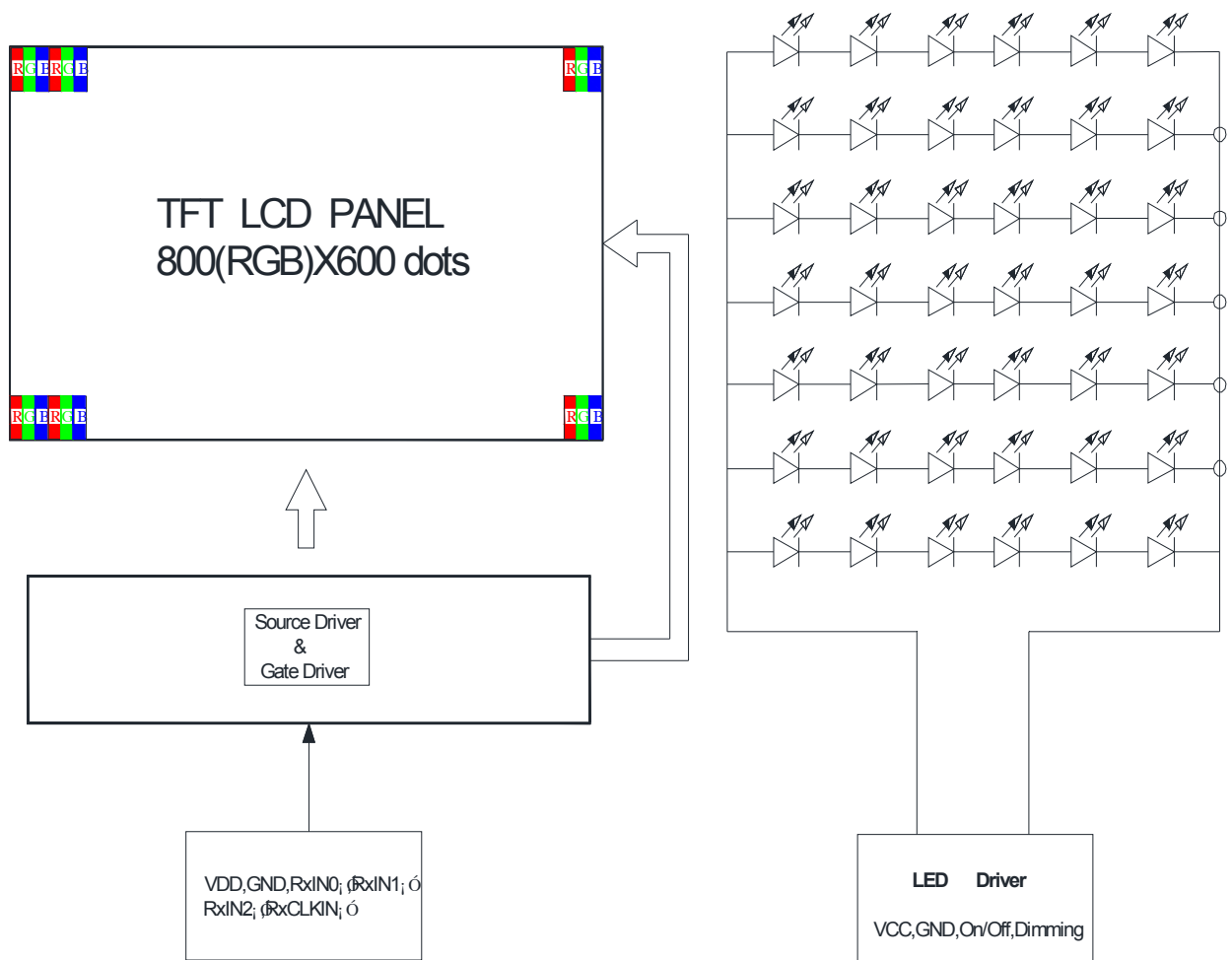

6. Displayed Color and Input Data

	Color & Gray Scale	Data Signal																	
		R5	R4	R3	R2	R1	R0	G5	G4	G3	G2	G1	G0	B5	B4	B3	B2	B1	B0
Basic Color	Black	0	0	0	0	0	0	0	0	0	0	0	0	0	0	0	0	0	0
	Red(0)	1	1	1	1	1	1	0	0	0	0	0	0	0	0	0	0	0	0
	Green(0)	0	0	0	0	0	0	1	1	1	1	1	1	0	0	0	0	0	0
	Blue(0)	0	0	0	0	0	0	0	0	0	0	0	0	1	1	1	1	1	1
	Cyan	0	0	0	0	0	0	1	1	1	1	1	1	1	1	1	1	1	1
	Magenta	1	1	1	1	1	1	0	0	0	0	0	0	1	1	1	1	1	1
	Yellow	1	1	1	1	1	1	1	1	1	1	1	1	0	0	0	0	0	0
	White	1	1	1	1	1	1	1	1	1	1	1	1	1	1	1	1	1	1
Red	Black	0	0	0	0	0	0	0	0	0	0	0	0	0	0	0	0	0	0
	Red(62)	0	0	0	0	0	1	0	0	0	0	0	0	0	0	0	0	0	0
	Red(61)	0	0	0	0	1	0	0	0	0	0	0	0	0	0	0	0	0	0
	:	:	:	:	:	:	:	:	:	:	:	:	:	:	:	:	:	:	:
	Red(31)	0	1	1	1	1	1	0	0	0	0	0	0	0	0	0	0	0	0
	:	:	:	:	:	:	:	:	:	:	:	:	:	:	:	:	:	:	:
	Red(1)	1	1	1	1	1	0	0	0	0	0	0	0	0	0	0	0	0	0
	Red(0)	1	1	1	1	1	1	0	0	0	0	0	0	0	0	0	0	0	0
Green	Black	0	0	0	0	0	0	0	0	0	0	0	0	0	0	0	0	0	0
	Green(62)	0	0	0	0	0	0	0	0	0	0	1	0	0	0	0	0	0	0
	Green(61)	0	0	0	0	0	0	0	0	0	0	1	0	0	0	0	0	0	0
	:	:	:	:	:	:	:	:	:	:	:	:	:	:	:	:	:	:	:
	Green(31)	0	0	0	0	0	0	0	1	1	1	1	0	0	0	0	0	0	0
	:	:	:	:	:	:	:	:	:	:	:	:	:	:	:	:	:	:	:
	Green(1)	0	0	0	0	0	0	1	1	1	1	1	0	0	0	0	0	0	0
	Green(0)	0	0	0	0	0	0	1	1	1	1	1	1	0	0	0	0	0	0
Blue	Black	0	0	0	0	0	0	0	0	0	0	0	0	0	0	0	0	0	0
	Blue(62)	0	0	0	0	0	0	0	0	0	0	0	0	0	0	0	0	0	1
	Blue(61)	0	0	0	0	0	0	0	0	0	0	0	0	0	0	0	0	1	0
	:	:	:	:	:	:	:	:	:	:	:	:	:	:	:	:	:	:	:
	Blue(31)	0	0	0	0	0	0	0	0	0	0	0	0	0	1	1	1	1	1
	:	:	:	:	:	:	:	:	:	:	:	:	:	:	:	:	:	:	:
	Blue(1)	0	0	0	0	0	0	0	0	0	0	0	0	1	1	1	1	1	0
	Blue(0)	0	0	0	0	0	0	0	0	0	0	0	0	1	1	1	1	1	1

0 : Low level voltage, 1 :High level voltage

Each basic color can be displayed in 64 gray scales from 6 bit data signals. With the combination of total 18 bit data signals, the 262,144-color display can be achieved on the screen.

7. Reliability Condition

No change on display and in operation under the following test condition.

Condition: Unless otherwise specified, tests will be conducted under the following condition.

Temperature: 20±5°C.

Humidity: 65±5%RH.

Tests will be not conducted under functioning state.

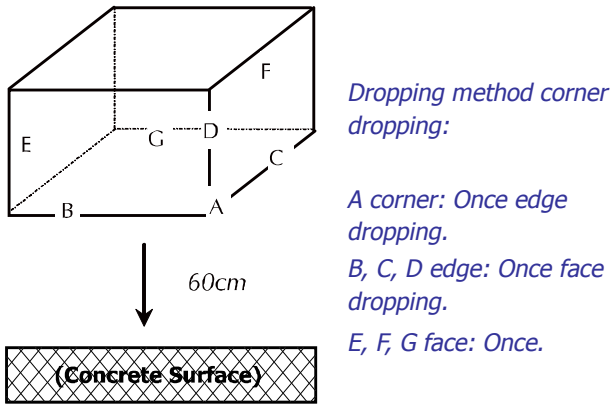
No.	Parameter	Condition	Notes
1	High Temperature Operating	70°C±2°C, 240hrs (Operation state).	
2	Low Temperature Operating	-20°C±2°C, 240hrs (Operation state).	1
3	High Temperature Storage	80°C±2°C, 240hrs.	2
4	Low Temperature Storage	-30°C±2°C, 240hrs.	1,2
5	High Temperature and High Humidity Operation Test	60°C±2°C, 90%, 240hrs.	1,2
6	Vibration Test	Total fixed amplitude: 1.5mm. Vibration Frequency: 10~55Hz. One cycle 60 seconds to 3 direction of X, Y, Z each 15 minutes.	3
7.	Drop Test	To be measured after dropping from 60cm high on the concrete surface in packing state. 	

- Notes:
1. No dew condensation to be observed.
 2. The function test shall be conducted after 4 hours storage at the normal temperature and humidity after removed from the test chamber.
 3. Vibration test will be conducted to the product itself without putting I in a container.

8. Dimensional Outlines

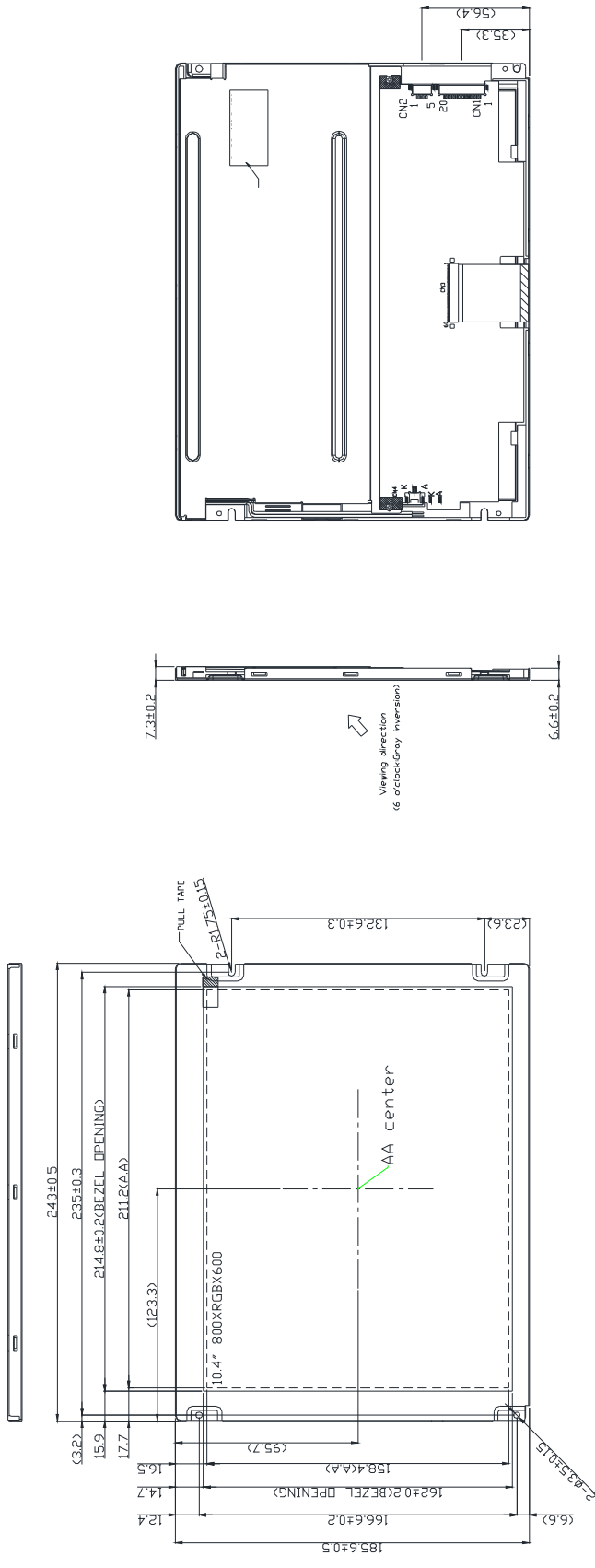

CN2

No.	Symbol
1	VCC
2	GND
3	DN/OFF
4	Dimming
5	GND

CN1

No.	Symbol
1	VDD
2	VDD
3	GND
4	GND
5	Rx1IN-
6	Rx1IN+
7	GND
8	Rx2IN-
9	Rx2IN+
10	GND
11	Rx2I2-
12	Rx2I2+
13	GND
14	RxCLKIN-
15	RxCLKIN+
16	GND
17	NC
18	NC
19	NC
20	NC

CN1: SMT MSB24013P20HA or Equivalent
 CN2: ENTRY 3808K-F05N-03L or Equivalent

9. Incoming Inspection Standards

9.1 Inspection and Environment Conditions

9.1.1 Inspection Conditions:

- (1) Inspection Distance: 35 cm±5cm
- (2) View Angle : Light-on Inspection Angle : ±5°
Cosmetic Inspection Angle : ±45°

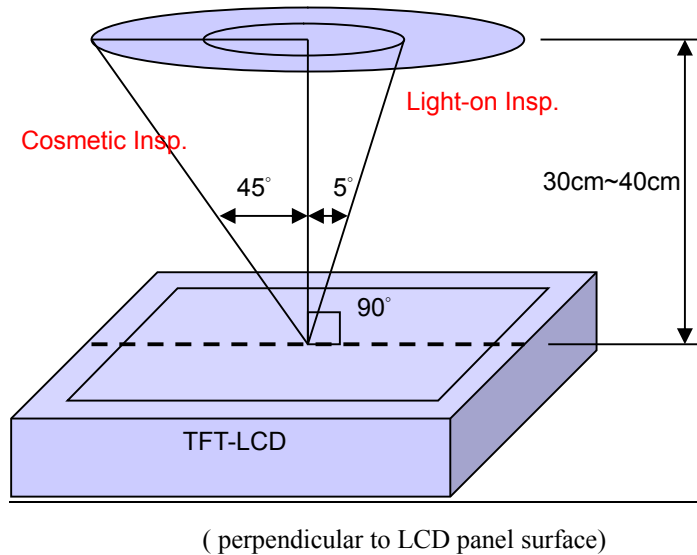

9.1.2 Environment Conditions:

Ambient Temperature		23°C ±5°C
Ambient Humidity		55±10%RH
Ambient Illumination	Cosmetic Inspection	more than 600 Lux
	Functional Inspection	300~500 Lux

9.1.3 Sampling Conditions:

- (1) Lot Size: Quantity of shipment lot per model
- (2) Sampling Method:

Sampling Plan		MIL-STD-105E
		Normal Inspection, Single Sampling Level II
AQL	Major Defect	1.0%
	Minor Defect	1.5%

- (3) The classification of Major(MA) and Minor(MI) defects is shown as 3. Inspection Criteria.

9.1.4 Inspection Criteria

9.1.4.1 Cosmetic Inspection(Panel):

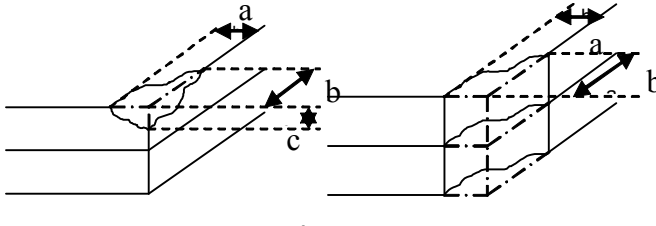
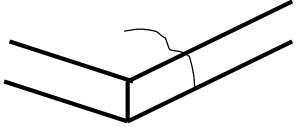
Item	Judgment Criteria	Classification
Chipping on Panel	 <p>$a \leq 3.0\text{mm} \cdot b \leq 3.0\text{mm} \cdot c \leq t$ (Bottom glass thickness)</p>	MA
Scratch on Panel *Note-2	<p>$W \leq 0.05\text{mm}$ or $L < 5\text{mm}$: Ignored $0.05\text{mm} < W \leq 0.1\text{mm}$ and $L \leq 5\text{mm}$: $N \leq 5$ $W > 0.1\text{mm}$ or $L > 5\text{mm}$: Not allowed</p>	MI
Bubble or Dent on Panel *Note-3	<p>$D \leq 0.2\text{mm}$: Ignored $0.2\text{mm} < D \leq 0.3\text{mm}$: $N \leq 5$ $D > 0.3\text{mm}$: Not allowed</p>	MI
Panel Crack	 <p>Not Allowed crack</p>	MA
Bezel Deformation	Obvious deformation is not allowed.	MI
Bezel Oxidation	Not allowed if it rusts continuously over 1 cm (It is out of warranty with rusted tin plate)	MI
Bezel Scratch	$L \leq 20\text{mm}$, $W \leq 0.2$, $N \leq 3$	MI
Metal Squash Dent /Flange(Front Side)	$D(W) \leq 1, L \leq 3, N \leq 3;$	MI
B/L High Voltage Wire Denudation	Not allowed	MA
Polarizer flaw or leak out resin	Defect is defined as the active area.	MI
Outline Dimension	Must in Spec, refer to related product spec.	MI

9.1.4.2 Functional Inspection:

Item	Judgment Criteria			Classification
	Area(Note1)	I	O	
Point Defect	Bright dot	Random	2	
		2 dots adjacent	0	0
		3 dots adjacent or more	0	0
	Dark dot	Random	3	
		2 dots adjacent	0	
		3 dots adjacent or more	0	0
	Total Dot Defect		5	
	Distance	Distance between Bright and Bright dot	$L \geq 5\text{mm}$	
		Distance between Bright and Dark dot	$L \geq 5\text{mm}$	
		Distance between Dark dot	$L \geq 5\text{mm}$	
(1) It is defined as Point Defect if defect area $> 0.5\text{dot}$ (2) It is ignored if defect area $\leq 0.5\text{dot}$ (3) Weak point defect will be defined as Bright Dot if it can be observed through ND filter 5% (Full Screen Black Inspection)				MI
Line Defect	Obvious vertical or horizontal line defect is not allowed.			MA
Mura	Not allowed if it can be observed through ND Filter 5 %			MI
Foreign Material in spot shape *Note-3	$D \leq 0.2\text{mm}$: Ignored $0.2\text{mm} < D \leq 0.5\text{mm}$: $N \leq 8$ $D > 0.5\text{mm}$: Not allowed			MI
Foreign Material in line or spiral shape *Note-4	$W \leq 0.05\text{mm}$ or $L \leq 5\text{mm}$: Ignored $0.05\text{mm} < W \leq 0.2\text{mm}$ and $L 1.0\text{mm} \leq 5\text{mm}$: $N \leq 8$ $W > 0.2\text{mm}$ or $L > 5\text{mm}$: Not allowed			MI
Display Function Abnormal	No Malfunction can be allowed			MA

Note-1 : I/O Area Definition

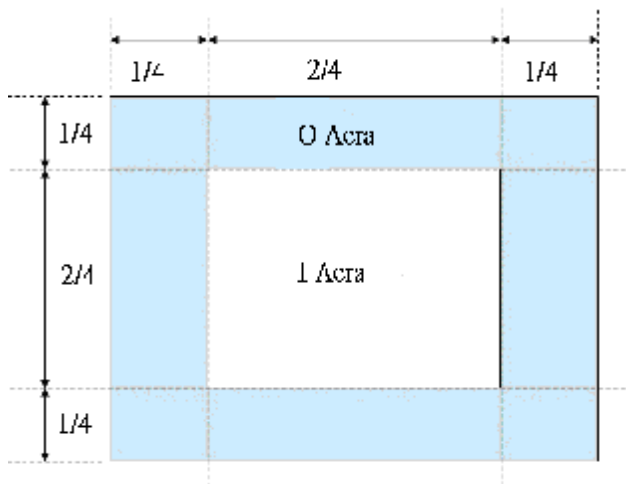

Note-2 : Polarizer Scratch

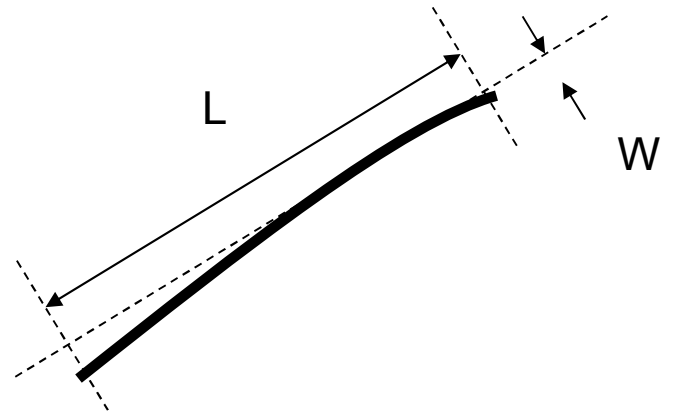

Note-3 : Spot Foreign Material
($W \geq L / 4$)

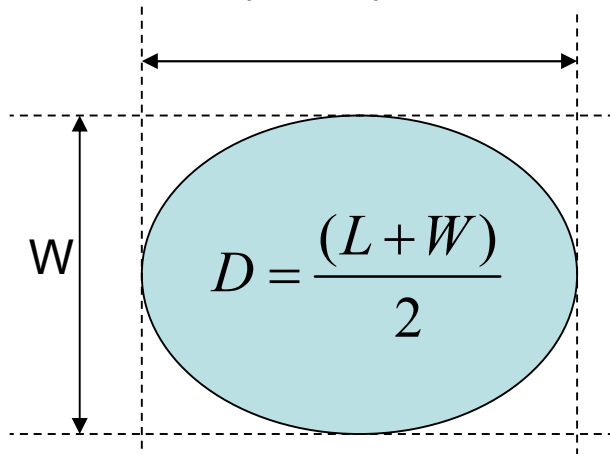

Note-4 : Line or Spiral Foreign Material
($W < L / 4$)

