

**DISPLAY Elektronik GmbH**

# DATA SHEET

**TFT MODULE**

**DEM 800480T TMH-PW-N**

**7" TFT**

*Product Specification*

*Version: 0*

17.02.2017

# GENERAL SPECIFICATION

---

MODULE NO. :

**DEM 800480T TMH-PW-N**

CUSTOMER

VERSION NO.	CHANGE DESCRIPTION	DATE
0	ORIGINAL VERSION	17.02.2017

PREPARED BY: ZX

DATE: 17.02.2017

APPROVED BY: MH

DATE: 17.02.2017

**CONTENTS**

1. GENERAL INFORMATION ..... 2

2. EXTERNAL DIMENSIONS ..... 3

3. ABSOLUTE MAXIMUM RATINGS ..... 4

4. ELECTRICAL CHARACTERISTICS ..... 4

5. PIN DESCRIPTION ..... 8

6. OPTICAL CHARACTERISTIC ..... 9

7. RELIABILITY ..... 12

8. LCD MODULES HANDLING PRECAUTIONS ..... 13

9. OTHERS ..... 13

**1. GENERAL INFORMATION**

<b>Item</b>	<b>Specification</b>	<b>Remark</b>
LCD Size	7.0 Inch (Diagonal)	-
Driver Element	a-Si TFT Active Matrix	-
Resolution	800 x RGB x 480	-
Display Mode	Normally White, Transmissive	-
Dot Pitch(W*H)	0.1905 x 0.1905	mm
Active Size(W*H)	152.40 x 91.44	mm
Module Size(W*H*T)	165.00 x 104.54 x 5.20	mm
Surface Treatment	Anti-Glare	-
Color Arrangement	RGB-Stripe	-
Interface	LVDS	-
Backlight Power Consumption	1.92	W
Optimum Viewing Direction	12 O'CLOCK	-
Weight	t.b.d.	-

2. EXTERNAL DIMENSIONS

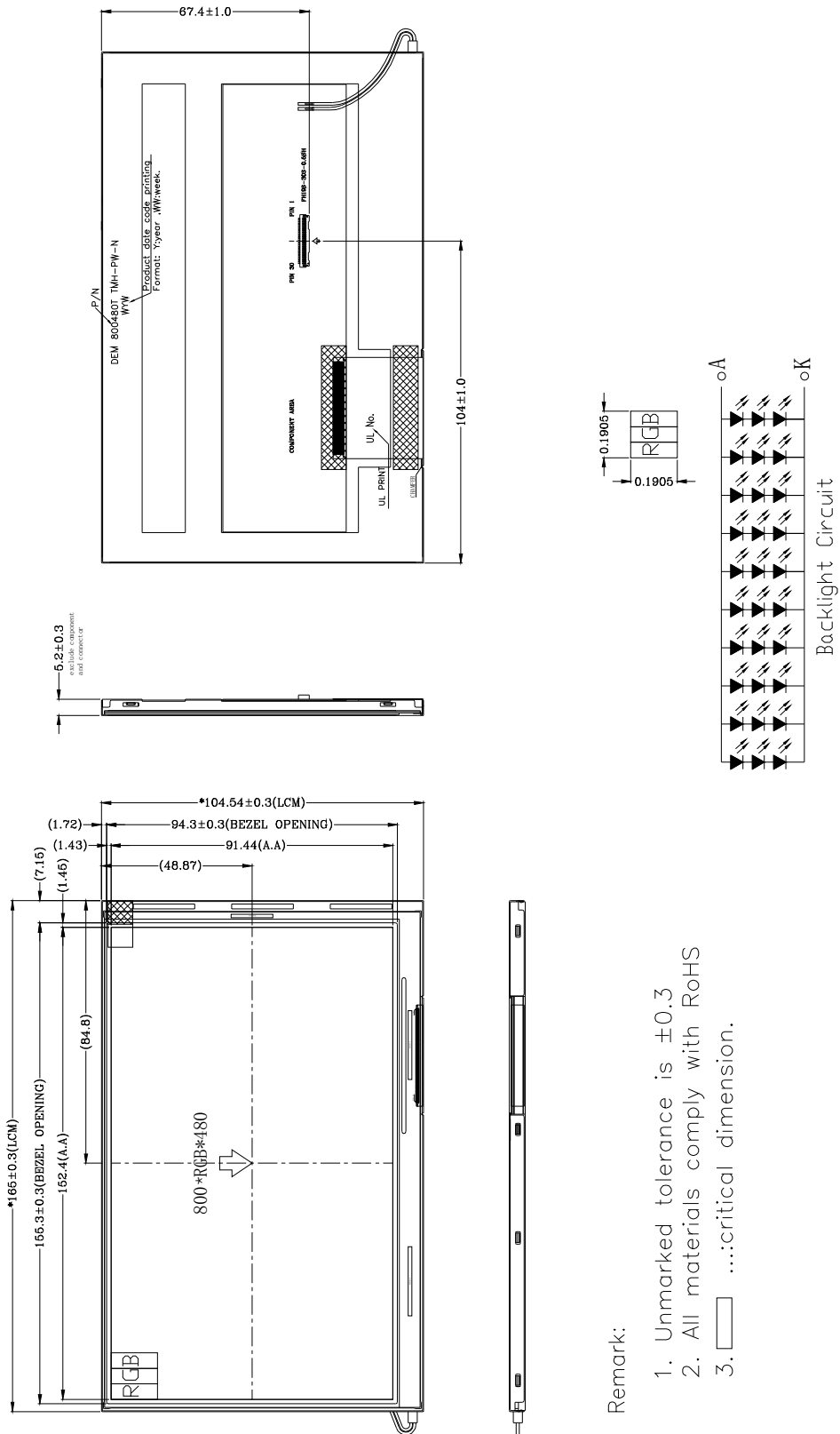

Remark:

1. Unmarked tolerance is  $\pm 0.3$
2. All materials comply with RoHS
3.  ...:critical dimension.

### 3. ABSOLUTE MAXIMUM RATINGS

Item	Symbol	Values		Unit	remark
		Min	Max		
Voltage	DVDD	-0.3	5.0	V	
	AVDD	6.5	13.5	V	
	VGH	-0.3	40.0	V	
	VGL	-20.0	0.3	V	
	VGH-VGL	-	40.0	V	
Operating Temperature	Top	-20	+70	°C	
Storage Temperature	Tst	-30	+80	°C	
LED Reverse Voltage	VR	-	1.2	V	Each LED, Note 2
LED Forward Current	IF	-	25	mA	Each LED

Note1: The absolute maximum rating values of this product are not allowed to be exceeded at any times. Should a module be used with any of the absolute maximum ratings exceeded, the characteristics of the module may not be recovered, or in an extreme case, the module may be permanently destroyed.

Note2: VR condition: Zener Diode 20mA

### 4. ELECTRICAL CHARACTERISTICS

#### 4.1 Typical Operation Conditions

Item	Symbol	Values			Unit	remark
		Min	Typ.	Max		
Voltage	DVDD	3.0	3.3	3.6	V	
	AVDD	10.2	10.4	10.6	V	
	VGH	16	18	19	V	
	VGL	-7	-6	-5	V	
Input signal voltage	Vcom	4.1	4.6	5.1	V	
Input logic high voltage	Tst	0.7DVDD	-	DVDD	V	Note 3
Input logic low voltage	Vih	0	-	0.3DVDD		

NOTE 1: be sure to apply DVDD and VGL to the LCD first, and then apply VGH.

NOTE 2: DVDD setting should match the signals output voltage (refer to NOTE 3) of Customer's system.

**4.2 Current Consumption**

Item	Symbol	Values			Unit	remark
		Min	Typ.	Max		
Current for driver	IGH	-	TBD		mA	
	IGL	-	TBD		mA	
	IDVDD	-	TBD		mA	
	ISVDD	-	TBD		mA	

**4.3 Backlight Driving Conditions**

Item	Symbol	Values			Unit	remark
		Min	Typ.	Max		
Voltage for LED Backlight	VL	-	9.6	-	V	NOTE1
Current for LED Backlight	IL	-	200	-	mA	-
LED Lifetime	IDVDD	30.000	50.000	-	Hr	NOTE2

Note 1: the LED supply voltage is defined by the number of LED at Ta=25°C and IL=160mA.

Note 2: the “LED life time” is defined as the module brightness decrease to 50% original brightness at Ta=25°C and IL=160mA. The LED lifetime could be decreased if operating IL is larger than 160mA.

Note 3: Typ. Specification: Gray –level test pattern;  
 Max. Specification: Black –level test pattern;



(a) Gray-level test pattern

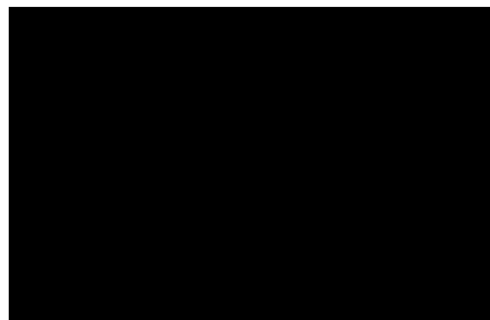

(b) Black-level test pattern

4.4 Power Sequence

a. Power on:

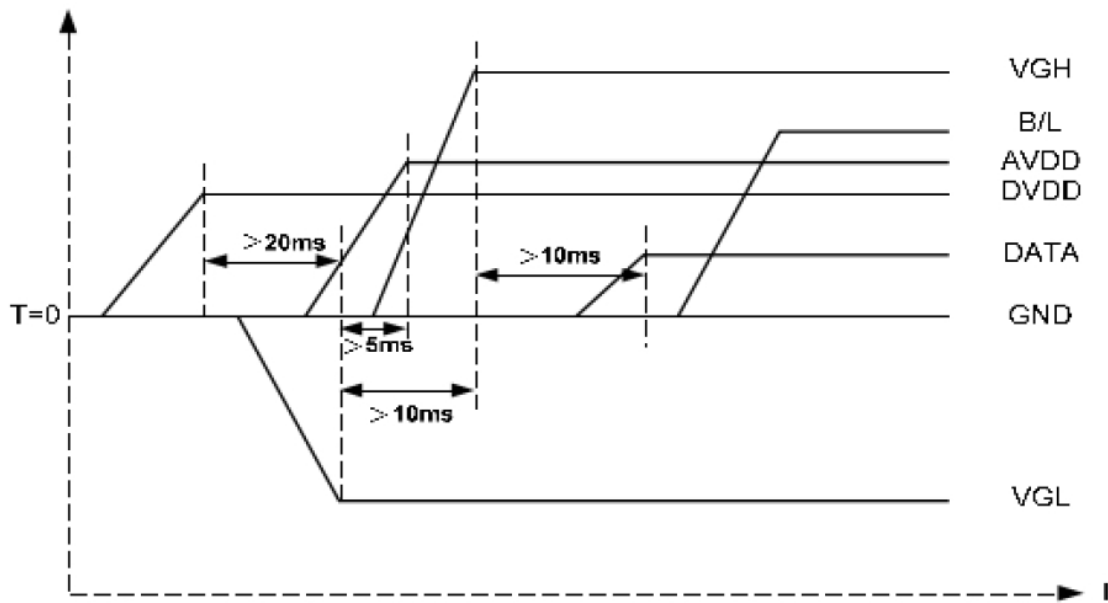

DV<sub>DD</sub>→VGL→VGH→Data→B/L

b. Power off:

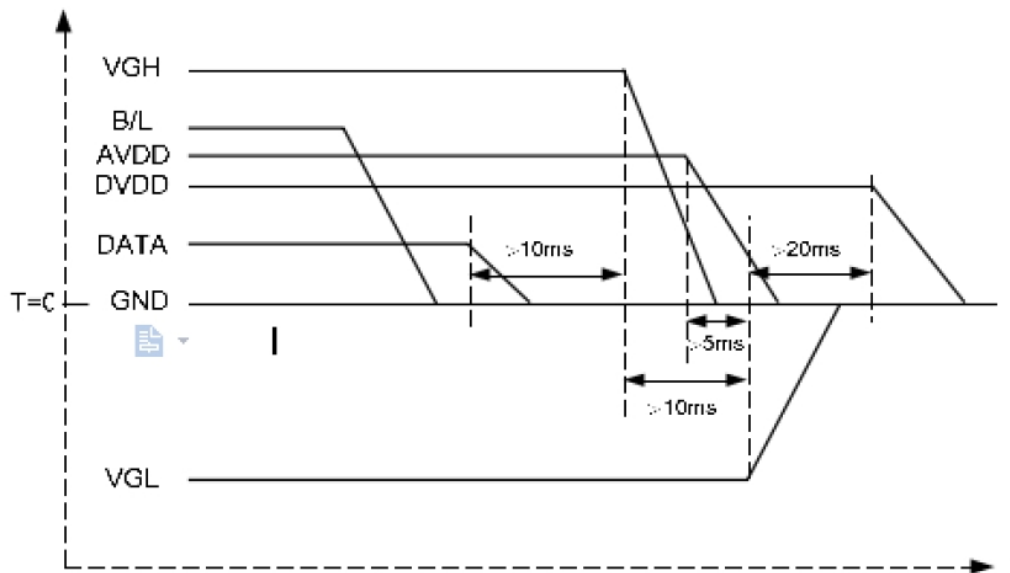

B/L→Data→VGH→VGL→DV<sub>DD</sub>

Note: Data include R0~R5, B0~B5, GO~G5, DCLK, DE.



4.5 Power Sequence

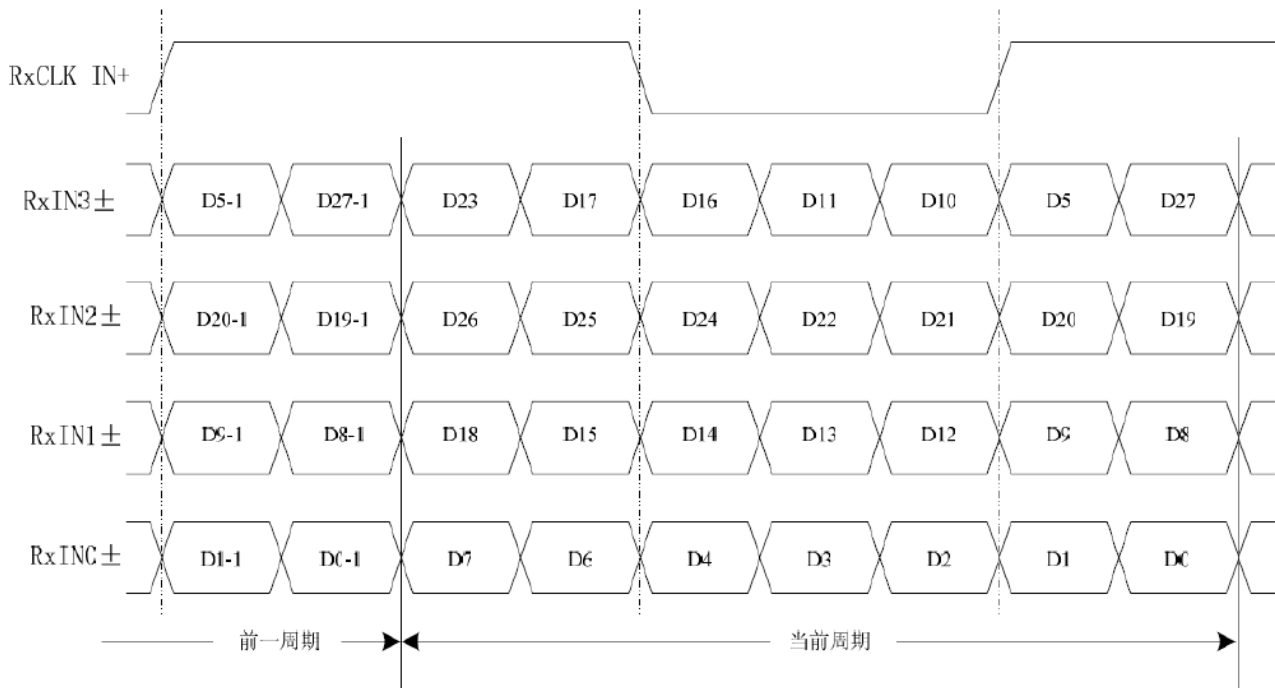

**5. PIN DESCRIPTION**

FPC connector is used for the module electronics interface. The recommended model is FH12A-50S-0.5SH manufactured by Hirose.

<b>Pin No.</b>	<b>Symbol</b>	<b>I/O</b>	<b>Description</b>
1	VDD	P	Power supply for digital circuit
2	VDD	P	Power supply for digital circuit
3	VDD	P	Power supply for digital circuit
4	NC	/	Not connection
5	VSS	P	Ground
6	RX0-	I	-LVDS differential data input
7	RX0+	I	+LVDS differential data input
8	VSS	P	Ground
9	RX1-	I	-LVDS differential data input
10	RX1+	I	+LVDS differential data input
11	VSS	P	Ground
12	RX2-	I	-LVDS differential data input
13	RX2+	I	+LVDS differential data input
14	VSS	P	Ground
15	RXC-	I	-LVDS differential clock input
16	RXC+	I	+LVDS differential clock input
17	VSS	P	Ground
18	RX3-	I	-LVDS differential data input
19	RX3+	I	+LVDS differential data input
20	VSS	P	Ground
21	VSS	P	Ground
22	DITHB	I	Dither Function Control Pin
23	VSS	P	Ground
24	U/D	I	Up Or Down Display Control
25	L/R	I	Left Or Right Display Control
26	NC	/	Not connection
27	VLED	P	Backlight Power Input(5v)
28	VLED	P	Backlight Power Input(5v)
29	VLED	P	Backlight Power Input(5v)
30	VLED	P	Backlight Power Input(5v)

I: INPUT O: OUTPUT P: POWER

**6. OPTICAL CHARACTERISTIC**

Item	Symbol	Conditions	Specifications			Unit	Note
			Min	Typ.	Max		
Luminance	L	Normal $\theta = \Phi = 0^\circ$	-	600	-	Cd/m <sup>2</sup>	(Note 6)
Contrast Ratio	CR		150	250	-	-	(Note 4)
Response Time	Ton		-	10	20	ms	(Note 3)
	Toff		-	15	30	ms	
CIE Color Coordinate (White)	Wx		-	0.290	-	-	-
	Wy		-	0.320	-	-	-
Luminance Uniformity	YU		70	75	-	%	(Note 7)
VIEWING ANGLE CR ≥ 10	$\theta_L$	$\Phi = 180^\circ$ (9 0' CLOCK)	60	70	-	Degree	(Note 1)
	$\theta_R$	$\Phi = 0^\circ$ (3 0' CLOCK)	60	70	-		
	$\theta_T$	$\Phi = 90^\circ$ (12 0' CLOCK)	50	60	-		
	$\theta_B$	$\Phi = 270^\circ$ (6 0' CLOCK)	60	70	-		

TEST CONDITIONS:

- 1: DVDD=3.3V, IL=200mA( Backlight Current), The Ambient Temperature is 25°C
2. The test system refers to note 2.

Note 1: Definition of viewing angle range

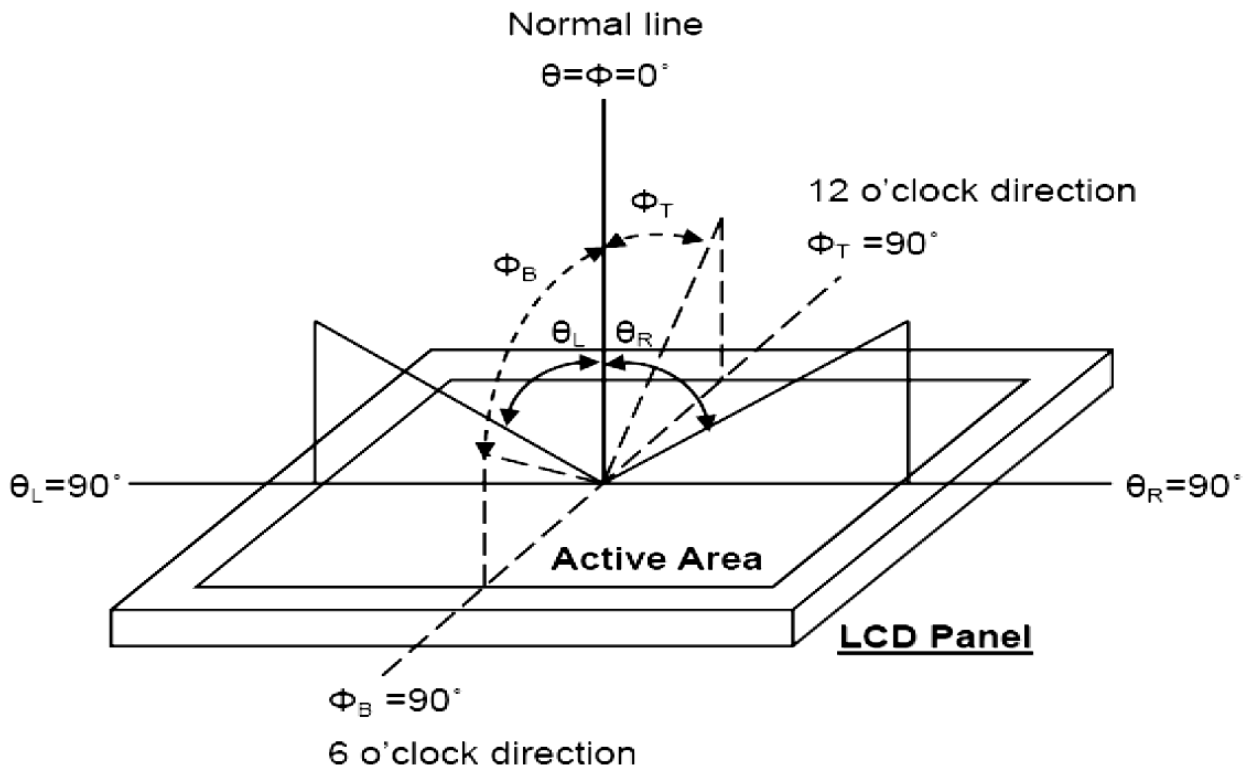

Note 2: Test equipment setup:

After stabilizing and leaving the panel alone at a driven temperature for 10 minutes, the measurement should be executed. Measurement should be executed in a stable, windless, and dark room. Optical specifications are measured by Topcon BM-7 luminance meter 1.0° field of view at a distance of 50cm and normal direction.

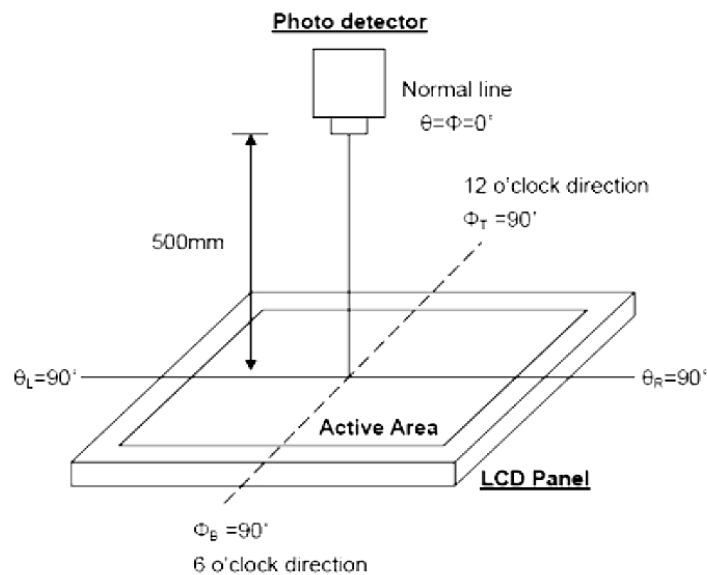

Note 3: Definition of Response time:

The response time is defined as the LCD optical switching time interval between “White state and “Black” state. Rise time,  $T_r$ , is the time between photo detector output intensity changed from 90% to 10% . And fall time,  $T_f$ , is the time between photo detector output Intensity changed from 10% to 90% .

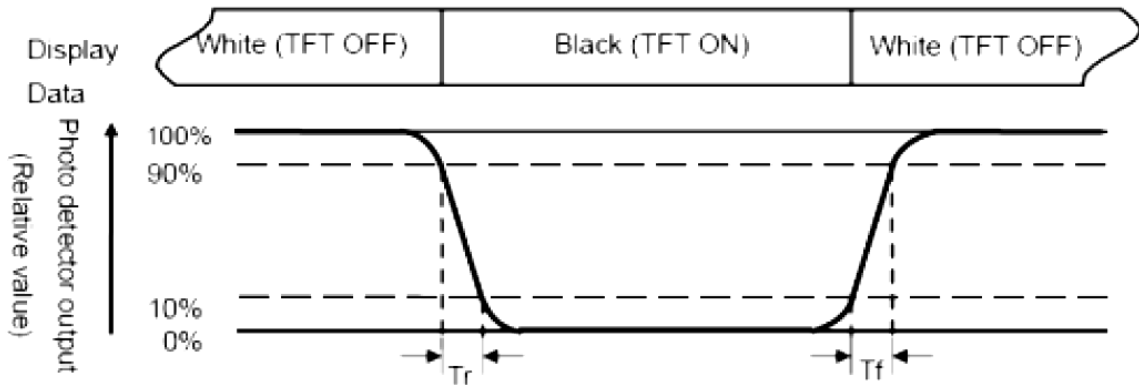

Note 4: Definition of contrast ratio:

The contrast ratio is defined as the following expression.

$$\text{Contrast ratio (CR)} = \frac{\text{Luminance measured when LCD on the "White" state}}{\text{Luminance measured when LCD on the "Black" state}}$$

Note 5: White  $V_i = V_{i50} \pm 1.5V$

Black  $V_i = V_{i50} \pm 2.0V$

“±” means that the analog input signal swings in phase with VCOM signal.

“±” means that the analog input signal swings out of phase with VCOM signal.

The 100% transmission is defined as the transmission of LCD panel when all the input terminals of module are electrically opened.

Note 6: Definition of color chromaticity (CIE 1931)

Color coordinates measured at the center point of LCD

Note 7: Measured at the center area of the panel when all the input terminals of LCD panel are electrically opened.

$$\text{Note 8 : Uniformity (U)} = \frac{\text{Brightness (min)}}{\text{Brightness (max)}} \times 100\%$$

## 7. RELIABILITY

No.	Test Item	Description
1	High temperature operation	The sample should be allowed to stand at +70°C for 240 hours under driving condition and then returning it to normal temperature condition, and allowing it stand for 2 hours.
2	Low temperature operation	The sample should be allowed to stand at -20°C for 240 hours under driving condition and then returning it to normal temperature condition, and allowing it stand for 2 hours.
3	High temperature storage	The sample should be allowed to stand at +80°C for 240 hours under no-load condition and then returning it to normal temperature condition, and allowing it stand for 2 hours.
4	Low temperature storage	The sample should be allowed to stand at -30°C for 240 hours under no-load condition and then returning it to normal temperature condition, and allowing it stand for 2 hours.
5	Moisture storage	The sample should be allowed to stand at +60°C, 90%RH Max for 240 hours under no-load condition, then taking it out and drying it at normal temperature for 2 hours.
6	Thermal shock storage	The sample should be allowed to stand the following 10 cycles: -30°C for 30 minutes->normal temperature for 5 minutes-> +80°C for 30 minutes -> normal temperature for 5 minutes, as one cycle.
7	Packing vibration	Frequency range:10HZ~55HZ Amplitude of vibration:1.5mm Sweep time:12min X,Y, Z 2 hours for each direction.
8	Mechanical shock	100G 6ms, $\pm X \pm Y \pm Z$ 3 times for each direction
9	Low temperature storage	Height:60cm 1corner,3 edges,6 surfaces $\pm 2KV$ ,human body mode, 100Pf/1500 $\Omega$

## 8. LCD MODULES HANDLING PRECAUTIONS

- The display panel is made of glass. Do not subject it to a mechanical shock by dropping it from a high place, etc.
- 
- If the display panel is damaged and the liquid crystal substance inside it leaks out, do not get any in your mouth. If the substance come into contact with your skin or clothes promptly wash it off using soap and water.
- 
- Do not apply excessive force to the display surface or the adjoining areas since this may cause the color tone to vary.
- 
- The polarizer covering the display surface of the LCD module is soft and easily scratched. Handle this polarize carefully.
- 
- To prevent destruction of the elements by static electricity, be careful to maintain an optimum work environment.
- -Be sure to ground the body when handling the LCD module.
- -Tools required for assembly, such as soldering irons, must be properly grounded.
- -To reduce the amount of static electricity generated, do not conduct assembly and other work under dry conditions.
- -The LCD module is coated with a film to protect the display surface. Exercise care when peeling off this protective film since static electricity may be generated.
- 
- Storage precautions
- When storing the LCD modules, avoid exposure to direct sunlight or to the light of fluorescent lamps. Keep the modules in bags designed to prevent static electricity charging under low temperature / normal humidity conditions (avoid high temperature / high humidity and low temperatures below 0□). Whenever possible, the LCD modules should be stored in the same conditions in which they were shipped from our company.

## 9. OTHERS

- Liquid crystals solidify at low temperature (below the storage temperature range) leading to defective orientation of liquid crystal or the generation of air bubbles (black or white). Air bubbles may also be generated if the module is subjected to a strong shock at a low temperature.
- If the LCD modules have been operating for a long time showing the same display patterns may remain on the screen as ghost images and a slight contrast irregularity may also appear. Abnormal operating status can be resumed to be normal condition by suspending use for some time. It should be noted that this phenomena does not adversely affect performance reliability.
- To minimize the performance degradation of the LCD modules resulting from caused by static electricity, etc. exercise care to avoid holding the following sections when handling the modules:
  - Exposed area of the printed circuit board
  - Terminal electrode sections.