

DISPLAY Elektronik GmbH

DATA SHEET

LCD MODULE

DEM 40271 SYH-LY-CYR22

Product Specification

Version :1

12/June/2008

GENERAL SPECIFICATION

MODULE NO. :

DEM 40271 SYH-LY-CYR22

CUSTOMER P/N

VERSION NO.	CHANGE DESCRIPTION	DATE
0	ORIGINAL VERSION	02.03.2007
1	CHANGE IC	12.06.2008

PREPARED BY: XYP

DATE: 12.06.2008

APPROVEDBY: MH

DATE: 12.06.2008

CONTENTS

1. FUNCTIONS & FEATURES2

2. MECHANICAL SPECIFICATIONS.....2

3. EXTERNAL DIMENSIONS.....3

4. BLOCK DIAGRAM.....4

5. PIN ASSIGNMENT.....4

6. PCB DRAWING AND DESCRIPTION5

7. BACKLIGHT ELECTRICAL/OPTICAL SPECIFCATIONS6

8. MAXIMUM ABSOLUTE POWER RATINGS6

9. ELECTRICAL CHARACTERISTICS7

10. INSTRUCTION DESCRIPTION9

11. STANDARD CHARACTER PATTERN(ST7066-0T)..... 10

12. LCD MODULES HAMDLING PRECAUTIONS..... 11

13. OTHERS..... 11

1. FUNCTIONS & FEATURES

MODULE NAME	LCD TYPE
DEM 40271 SYH-LY-CYR22	STN Yellow Green Transflective Positive Mode

- Viewing Direction : 6 o'clock
- Driving Scheme : 1/16 Duty Cycle, 1/5 Bias
- Power Supply Voltage : 5.0 Volt (typ.)
- V_{LCD} Adjustable For Best Contrast : 4.6 Volt (typ.)
- Display contents : 40 x 2 Characters
- Backlight : LED, Yellow-Green, Lightbox
- IC : ST7066-0T (English-Cyrillic)
- Internal Memory : CGROM (10,080 bits)
: CGRAM (64 x 8 bits)
: DDRAM (80 x 8 bits)
- CGROM : CGROM of the ST7066U-0T
- Interface : Easy Interface with 4-bit or 8-bit MPU
- Operating Temperature : -20°C to +70°C
- Storage Temperature : -30°C to +80°C

2. MECHANICAL SPECIFICATIONS

- Module Size : 182.00 x 33.50 x 14.00 mm
- Character Pitch : 3.78 x 6.09 mm
- Character Size : 3.28 x 5.69 mm
- Character Font : 5 x 8 dots
- Dot Size : 0.60 x 0.65 mm
- Gap Size : 0.07 x 0.07 mm

3. EXTERNAL DIMENSIONS

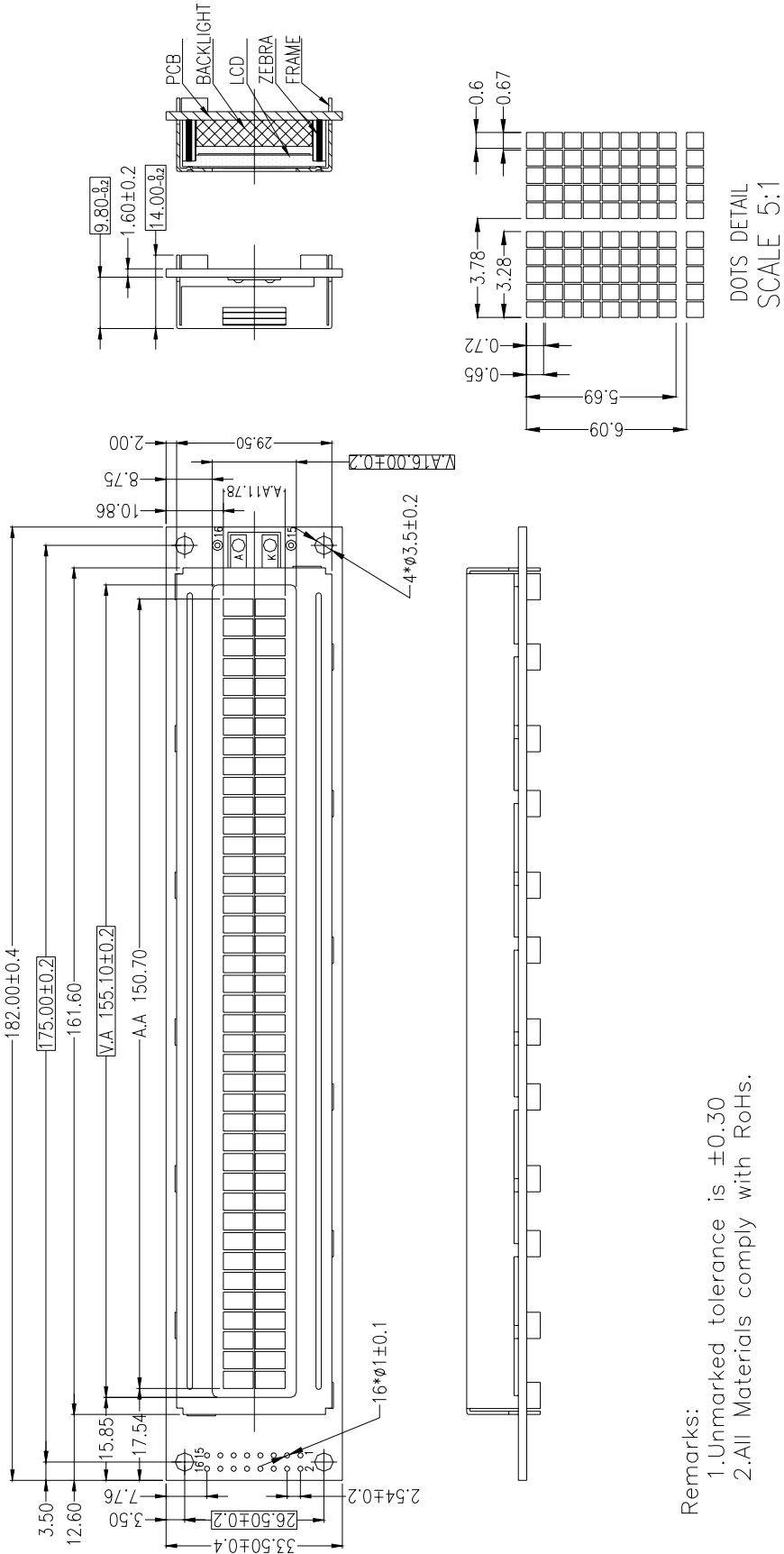

Remarks:
 1. Unmarked tolerance is ± 0.30
 2. All Materials comply with RoHs.

4. BLOCK DIAGRAM

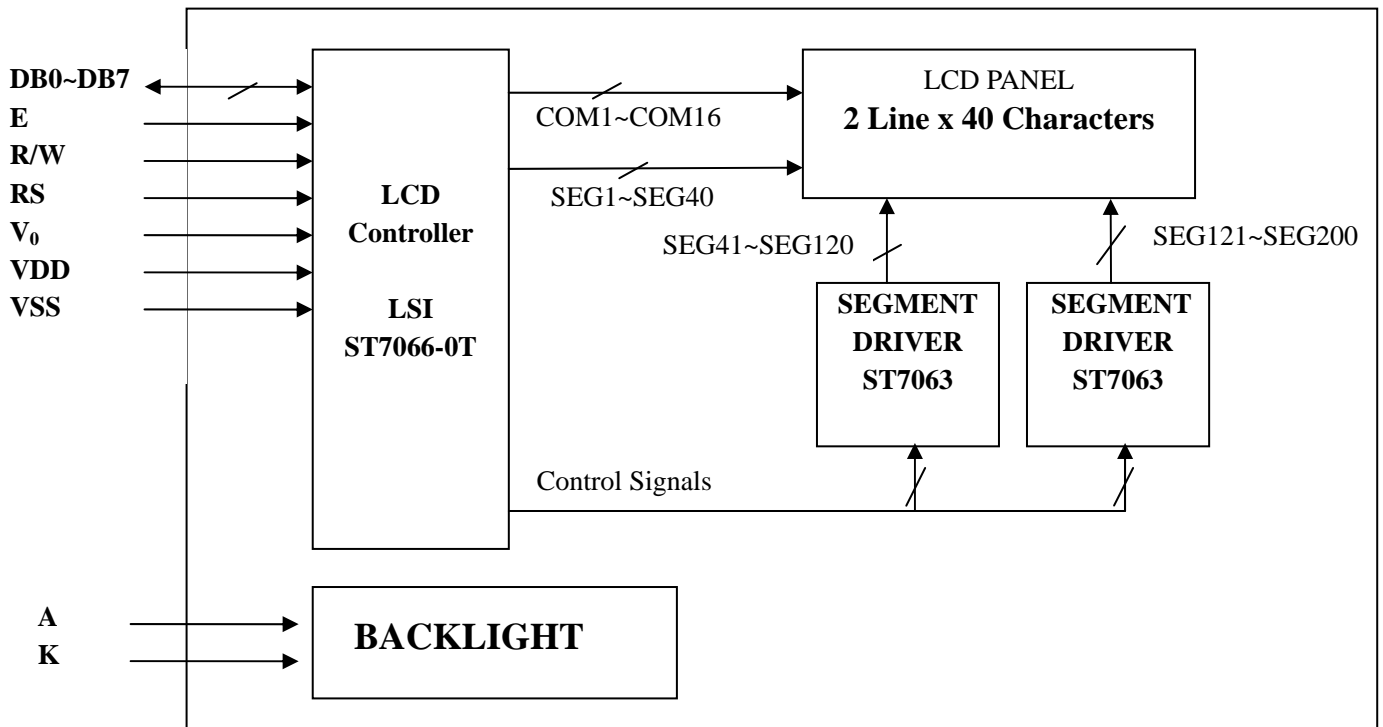

5. PIN ASSIGNMENT

Pin No.	Symbol	Function
1	VSS	Ground terminal of module.
2	VDD	Power terminal of module 5.0V.
3	V0	Power Supply for liquid crystal drive.
4	RS	Register select RS = 0...Instruction register RS = 1...Data register
5	R/W	Read /Write R/W = 1...Read R/W = 0...Write
6	E	Read/Write Enable Signal
7	DB0	Bi-directional data bus, data transfer is performed once, thru DB0 to DB7, in the case of interface data. Length is 8-bits; and twice, thru DB4 to DB7 in the case of interface data length is 4-bits. Upper four bits first then lower four bits.
8	DB1	
9	DB2	
10	DB3	
11	DB4	
12	DB5	
13	DB6	
14	DB7	
15	LED - (K)	Please also refer to 6. PCB drawing and description.
16	LED + (A)	

6. PCB DRAWING AND DESCRIPTION

6.1 PCB DRAWING

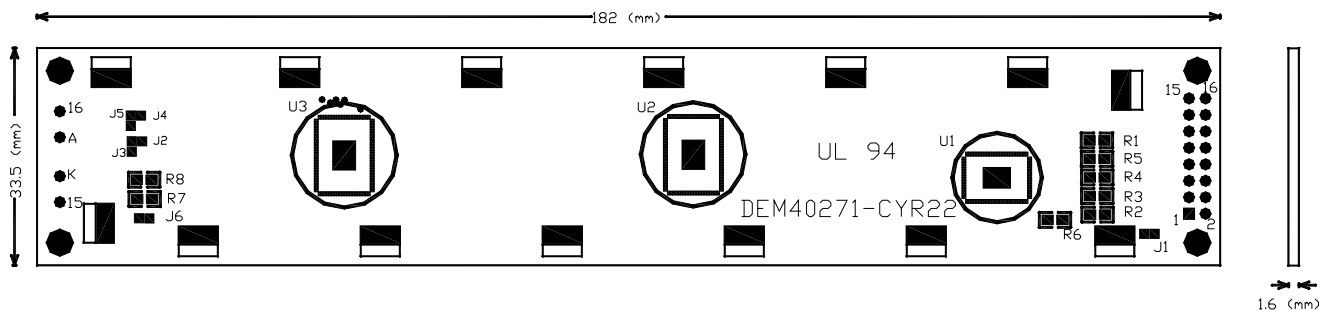

Note: The part no. DEM40271-CYR22 is printed on the PCB.

6.2 DESCRIPTION:

6-2-1 The polarity of the pin 15 and the pin 16 :

J3,J5	J2,J4	LED Polarity	
		15 Pin	16 Pin
Each open	Each closed	Anode	Cathode
Each closed	Each open	Cathode	Anode

Note : In application, J3=J5=0 Ohm , and J2 ,J4 should be open.

6-2-2 The metal-bezel is set be on ground when the J1 is closed . .

Note: In application , J1=0 Ohm

6-2-3 The LED resistor should can be bridged when the J6 is closed.

Note: In application J6 should be opened.

6-2-4 The R7 and the R8 are the LED resistor.

Note: In application, R7=R8=10 Ohm

7. BACKLIGHT ELECTRICAL/OPTICAL SPECIFICATIONS

7.1 Electrical-Optical Characteristics

Item	Symbol	MIN.	TYP.	MAX.	Unit	Condition
Forward Voltage	Vf	3.9	4.1	4.3	V	If= 260 mA
Forward Current	If				mA	
Power Dissipation	Pd		1.68		W	
Reverse Voltage	VR		10.0		V	Vr=10V
Reverse Current	IR			0.26	mA	
Luminous Intensity	Iv	160	180		cd/m ²	If= 260 mA
Luminous Uniformity	ΔL		80		%	If= 260 mA
Emission Wavelength	λP	569	572	575	nm	If= 260 mA
Spectral Range	Δλ		30			Ta= 25°C

7.2 BACKLIGHT DRAWING

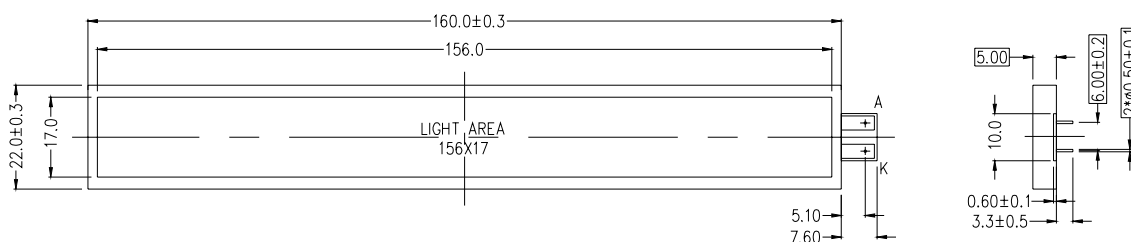

REMARKS:
UNMARKED TOLERANCE IS ±0.3
ALL MATERIALS COMPLY WITH ROHS.

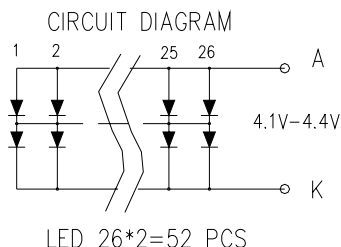

8. MAXIMUM ABSOLUTE POWER RATINGS

Item	Symbol	Standard value	Unit
Power supply voltage (1)	V _{DD}	-0.3~+7.0	V
Power supply voltage (2)	V ₀	V _{DD} -13.5~V _{DD} +0.3	V
Input voltage	V _{IN}	-0.3~V _{DD} +0.3	V
Operating temperature	T _{opr}	-20~+70	°C
Storage temperature	T _{stg}	-30~+80	°C

*Voltage greater than above may damage to the Circuit.

V_{DD} > V₁ > V₂ > V₃ > V₄ > V₅

9. ELECTRICAL CHARACTERISTICS

9-1 DC Characteristics ($V_{DD}=4.5V\sim 5.5V$)

Item	Symbol	Standard Value			Test Condition	Unit
		MIN	TYP	MAX		
Operating Voltage	V_{DD}	4.5	5	5.5	-----	V
Supply Current	I_{DD1}	----	0.35	0.6	$V_{DD}=5V, f_{osc}=270kHz$	mA
LCD Driving Voltage	V_{LCD}	3.0	4.6	13.0	$V_{DD}-V_5$ (1/5, 1/4 Bias)	V

9-2 AC Characteristics ($V_{DD}=4.5V\sim 5.5V$)

9-2-1. Write mode (writing data from MPU to ST7066)

Characteristic	Symbol	Min	Typ	Max	Unit	Test PIN
E Cycle Time	T_C	1200			ns	E
E Pulse width	T_{PW}	140			ns	E
E Rise/Fall Time	$T_R T_F$			25-	ns	E
Address Setup Time	T_{AS}	0			ns	RS,RW E
Address Hold Time	T_{AH}	10			ns	RS,RW E
Data Setup Time	T_{DSW}	40			ns	DB0~DB7
Data Hold Time	T_H	10			ns	DB0~DB7

Writing data from ST7066 to MPU

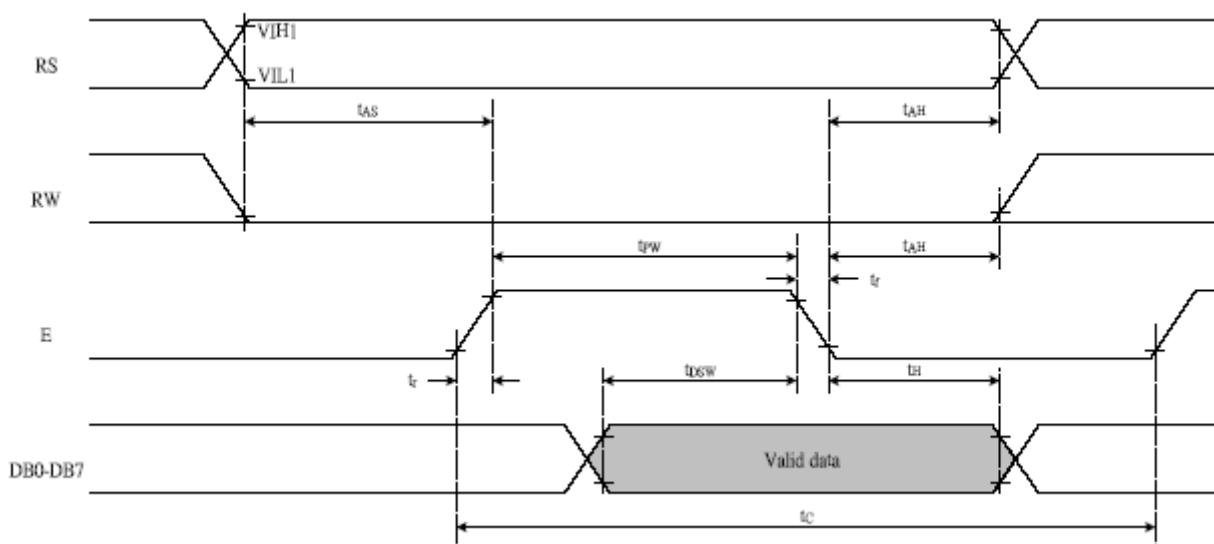

9-2-2.Read mode (Reading data from ST7066 to MPU)

Characteristic	Symbol	Min	Typ	Max	Unit	Test PIN
E Cycle Time	T_C	1200			ns	E
E Pulse width	T_{PW}	140			ns	E
E Rise/Fall Time	$T_R T_F$			25	ns	E
Address Setup Time	T_{AS}	0			ns	RW, RS,E
Address Hold Time	T_{AH}	10			ns	RW, RS,E
Data Setup Time	T_{DDR}			100	ns	DB0~DB7
Data Hold Time	T_{DH}	10			ns	DB0~DB7

Read data from ST7066 to MPU

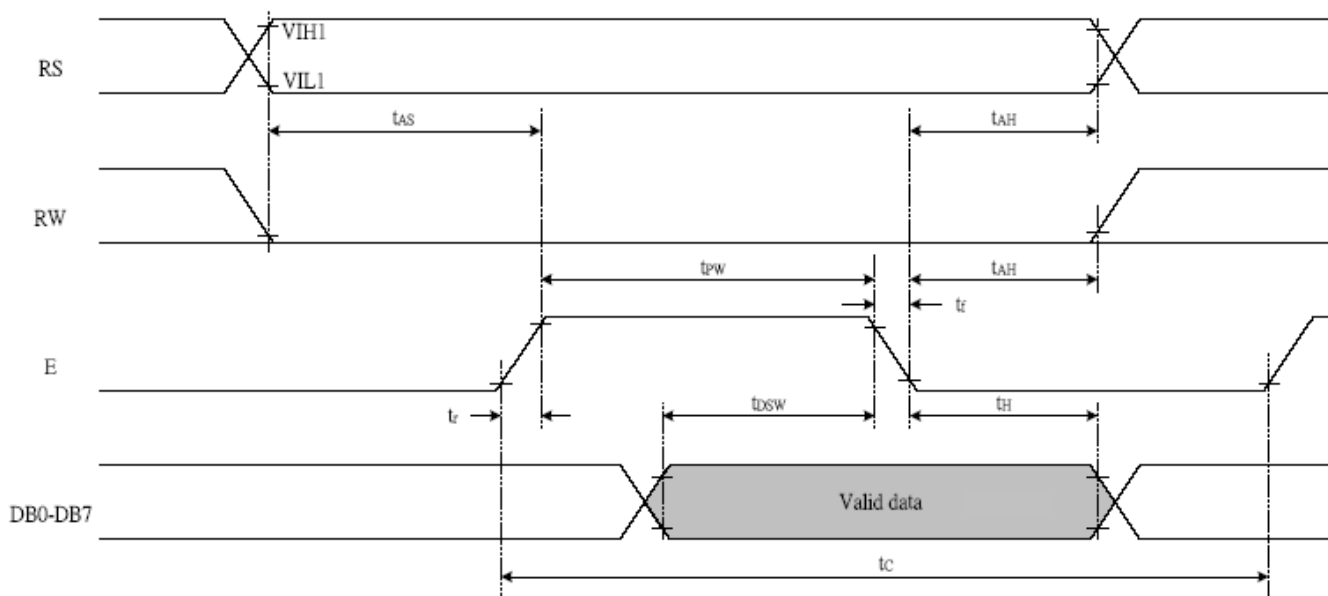

10. INSTRUCTION DESCRIPTION

Command	RS	R/W	DB7	DB6	DB5	DB4	DB3	DB2	DB1	DB0	Execution time (fosc=270KHz)	Remark
Clear Display	0	0	0	0	0	0	0	0	0	1	1.52ms	Write"20H" to DDRAM. And set DDRAM address to "00H" from AC
Return home	0	0	0	0	0	0	0	0	1	x	1.52ms	Set DDRAM address to "00H" from AC and return cursor to its original position if shifted. The contents of DDRAM are not changed.
Entry mode Set	0	0	0	0	0	0	0	1	I/D	S	37us	Sets cursor move direction and specifies display shift. These operations are performed during data write and read.
Display on/off control	0	0	0	0	0	0	1	D	C	B	37us	D=1: entire display on C=1: cursor on B=1: cursor position on
Cursor or Display Shift	0	0	0	0	0	1	S/C	R/L	x	x	37us	Set cursor moving and display shift control bit, and the direction, without changing DDRAM data.
function Set	0	0	0	0	1	DL	N	F	x	x	37us	DL: interface data is 8/4 bits N: number of line is 2/1 F: font size is 5x11/5x8
Set CGRAM address	0	0	0	1	AC5	AC4	AC3	AC2	AC1	AC0	37us	Set CGRAM address in address counter
Set DDRAM address	0	0	1	AC6	AC5	AC4	AC3	AC2	AC1	AC0	37us	Set DDRAM address in address counter
Read busy flag& address	0	1	BF	AC6	AC5	AC4	AC3	AC2	AC1	AC0	0us	Whether during internal operation or not can be known by reading BF. The contents of address counter can also be read.
Write data to RAM	1	0	D7	D6	D5	D4	D3	D2	D1	D0	37us	Write data into internal RAM (DDRAM/CGRAM)
Read data from RAM	1	1	D7	D6	D5	D4	D3	D2	D1	D0	37us	Read data from internal RAM (DDRAM / CGRAM)

Note:

Be sure the ST7066U is not in the busy state (BF=00 before sending an instruction from the MPU to the ST7066U. If an instruction is sent without checking the busy flag, the time between the first instruction and next instruction will take much longer than the instruction time itself. Refer to instruction table for the list of each instruction execution time.

11. STANDARD CHARACTER PATTERN(ST7066-0T)

Upper(4bit) Lower(4bit)	LLLL	LLLH	LLHL	LLHH	LHLL	LHLH	LHHL	LHHH	HLLL	HLLH	HLHL	HLHH	HHLL	HHLH	HHHL	HHHH
LLLL	CG RAM (1)															
LLLH	(2)															
LLHL	(3)															
LLHH	(4)															
LHLL	(5)															
LHLH	(6)															
LHHL	(7)															
LHHH	(8)															
HLLL	(1)															
HLLH	(2)															
HLHL	(3)															
HLHH	(4)															
HHLL	(5)															
HHLH	(6)															
HHHL	(7)															
HHHH	(8)															

12. LCD MODULES HANDLING PRECAUTIONS

- Please remove the protection foil of polarizer before using.
- The display panel is made of glass. Do not subject it to a mechanical shock by dropping it from a high place, etc.
- If the display panel is damaged and the liquid crystal substance inside it leaks out, do not get any in your mouth. If the substance come into contact with your skin or clothes promptly wash it off using soap and water.
- Do not apply excessive force to the display surface or the adjoining areas since this may cause the color tone to vary.
- The polarizer covering the display surface of the LCD module is soft and easily scratched. Handle this polarize carefully.
- To prevent destruction of the elements by static electricity, be careful to maintain an optimum work environment.
 - Be sure to ground the body when handling the LCD module.
 - Tools required for assembly, such as soldering irons, must be properly grounded.
 - To reduce the amount of static electricity generated, do not conduct assembly and other work under dry conditions.
 - The LCD module is coated with a film to protect the display surface. Exercise care when peeling off this protective film since static electricity may be generated.
- Storage precautions
When storing the LCD modules, avoid exposure to direct sunlight or to the light of fluorescent lamps. Keep the modules in bags designed to prevent static electricity charging under low temperature / normal humidity conditions (avoid high temperature / high humidity and low temperatures below 0°C). Whenever possible, the LCD modules should be stored in the same conditions in which they were shipped from our company.

13. OTHERS

- Liquid crystals solidify at low temperature (below the storage temperature range) leading to defective orientation of liquid crystal or the generation of air bubbles (black or white). Air bubbles may also be generated if the module is subjected to a strong shock at a low temperature.
- If the LCD modules have been operating for a long time showing the same display patterns may remain on the screen as ghost images and a slight contrast irregularity may also appear. Abnormal operating status can be resumed to be normal condition by suspending use for some time. It should be noted that this phenomena does not adversely affect performance reliability.
- To minimize the performance degradation of the LCD modules resulting from caused by static electricity, etc. exercise care to avoid holding the following sections when handling the modules:
 - Exposed area of the printed circuit board
 - Terminal electrode sections