

**DISPLAY Elektronik GmbH**

**DATA SHEET**

**LCD MODULE**

**DEM 128064F SBH-PW-N**

*Product Specification*

*Version: 6*

**02.06.2020**

# GENERAL SPECIFICATION

---

MODULE NO. :

## DEM 128064F SBH-PW-N

VERSION NO.	CHANGE DESCRIPTION	DATE
0	ORIGINAL VERSION	28.10.2008
1	CHANGE VLCD	02.12.2008
2	UPDATE	23.02.2017
3	UPDATE	15.06.2017
4	CORRECT BACKLIGHT THICKNESS	19.06.2017
5	CORRECT DRAWING PLUG END	06.02.2018
6	CHANGE THE BACKLIGHT FORWARD VOLTAGE	02.06.2020

PREPARED BY: XYP

DATE: 02.06.2020

APPROVED BY: MHI

DATE: 02.06.2020

**CONTENTS**

**1. FUNCTIONS & FEATURES ..... 2**

**2. MECHANICAL SPECIFICATIONS ..... 2**

**3. EXTERNAL DIMENSIONS ..... 3**

**4. BLOCK DIAGRAM..... 4**

**5. PIN DESCRIPTION..... 5**

**6. ABSOLUTE MAXIMUM RATINGS ..... 6**

**7. BACKLIGHT CHARACTERISTICS..... 6**

**8. ELECTRICAL CHARACTERISTICS ..... 7**

**9. COMMAND TABLE..... 10**

**10. LCD ARTWORK..... 11**

**11. LCD LABELING ..... 11**

**12. SEG LAYOUT..... 12**

**13 COM LAYOUT..... 12**

**14. PAD CONFIGURATION GRAPHIC DIMENSION ..... 13**

**15. IC LAYOUT ..... 13**

**16. QUALITY DESCRIPTION ..... 14**

**17. MODULE ACCEPTS QUALITY LEVEL (AQL). ..... 15**

**18. RELIABILITY TEST..... 15**

**19. LCD MODULES HANDLING PRECAUTIONS ..... 16**

**20. OTHERS..... 16**

**1. FUNCTIONS & FEATURES**

<b>MODULE NAME</b>	<b>LCD TYPE</b>
DEM 128064F SBH-PW-N	STN-Blue Transmissive Negative Mode

l Viewing Direction	: 6 O'clock
l Driving Scheme	: 1/65 Duty Cycle, 1/9 Bias
l Power Supply Voltage(Typ.)	: 3.0 V
l LCD Operation Voltage	: 9.8 V
l Display Contents	: 128x64 Dots
l Backlight color	: White
l Driver IC	: ST7565R-G (SITRONIX)
l Operating temperature	: -20°C ~ +70°C
l Storage temperature	: -30°C ~ +80°C
l RoHS Compliant	

**2. MECHANICAL SPECIFICATIONS**

l Module Size:	: 68.80 x 49.20 x 8.50 mm
l Viewing Area Size:	: 60.60 x 33.10 mm
l Active Area Size	: 55.01 x 27.49 mm
l Dot Pitch:	: 0.43 x 0.43 mm
l Dot Size:	: 0.40 x 0.40 mm

3. EXTERNAL DIMENSIONS

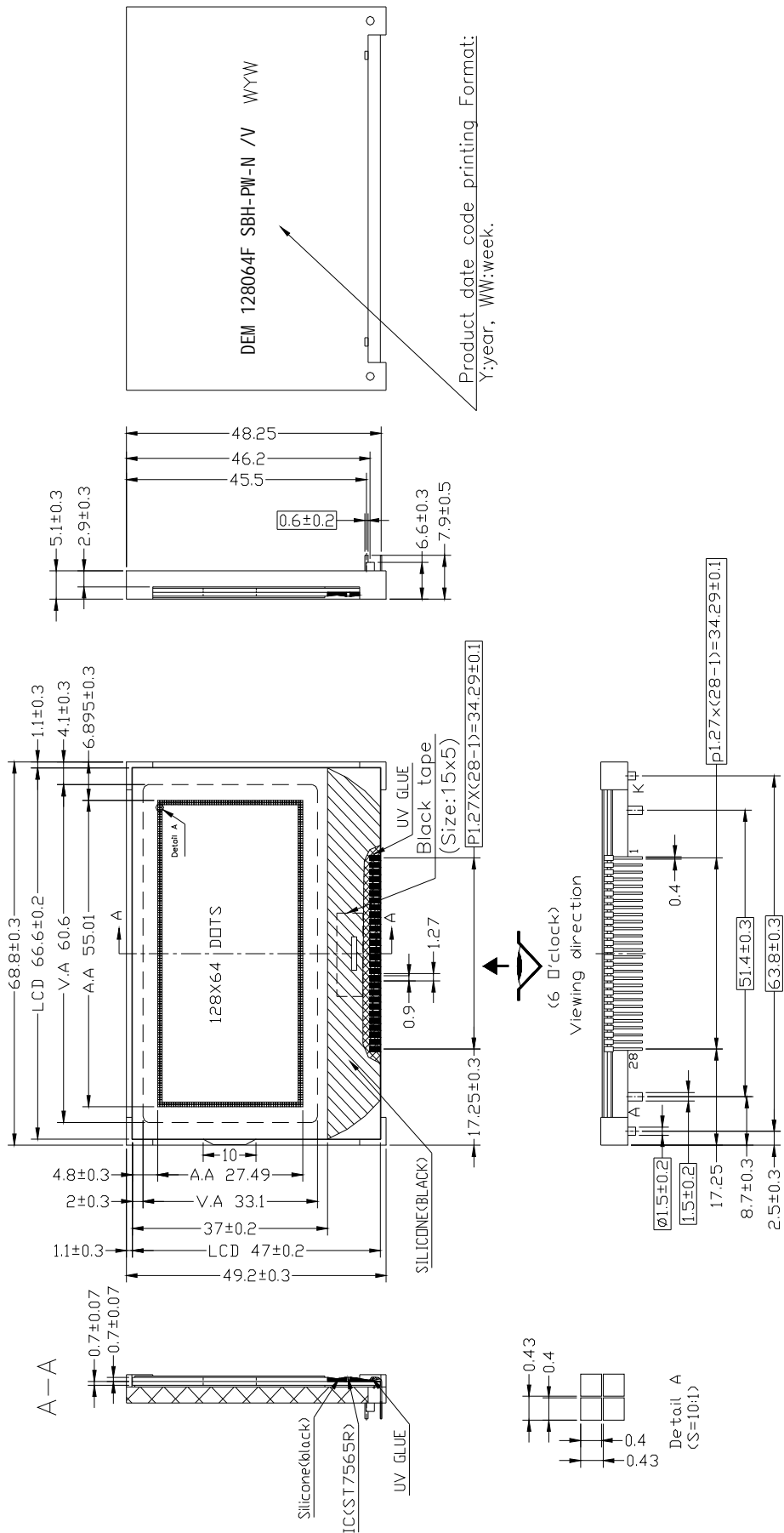

Remarks:  
 1. Unmarked tolerance is  $\pm 0.30$ ;  
 2. All material comply with RoHs.

4. BLOCK DIAGRAM

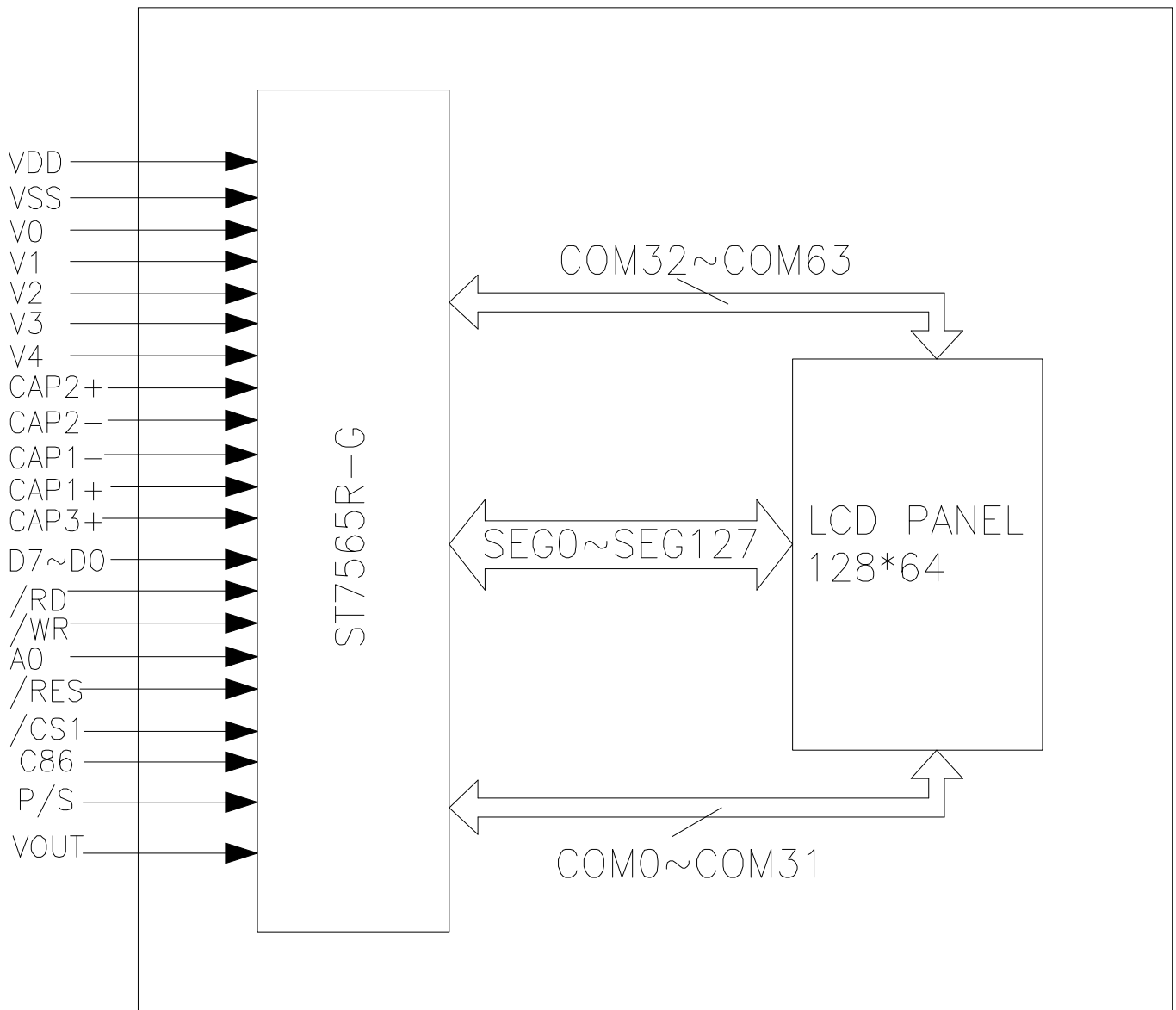

5. PIN DESCRIPTION

Pin No.	Name	I/O	Description																
1	/CS1	I	Chip enable terminal. It is active when /CS="L".																
2	/RES	I	When /RES is set to "L", the register settings are initialized (cleared). The reset operation is performed by the /RES signal level.																
3	A0	I	This is connect to the least significant bit of the normal MPU address bus, and it determines whether the data bits are data or command. A0 = "H": Indicates that D0 to D7 are display data. A0 = "L": Indicates that D0 to D7 are control data.																
4	/RW	I	When connected to 6800 series MPU, this pin is treated as the "R/W" signal of the 6800 MPU and decides the access type : When R/W = "H": Read. When R/W = "L": Write																
5	/RD	I	This is the enable clock input terminal of the 6800 Series MPU and is HIGH-active.																
6~13	D0~D7	I/O	This is an 8-bit bi-directional data bus that connects to an 8-bit or 16-bit standard MPU data bus.																
14	VDD	Supply	Power supply for logic.																
15	VSS	Supply	Ground.																
16	Vout	Supply	DC/DC voltage converter. Connect a capacitor between this terminal and VSS or VDD terminal.																
17	C3+	O	DC/DC voltage converter. Connect a capacitor between this terminal and the C1- terminal.																
18	C1-	O	DC/DC voltage converter. Connect a capacitor between this terminal and the C1+ terminal.																
19	C1+	O	DC/DC voltage converter. Connect a capacitor between this terminal and the C1- terminal.																
20	C2+	O	DC/DC voltage converter. Connect a capacitor between this terminal and the C2- terminal.																
21	C2-	O	DC/DC voltage converter. Connect a capacitor between this terminal and the C2+ terminal.																
22	V4	Supply	This is a multi-level power supply for the liquid crystal drive. The voltage Supply applied is determined by the liquid crystal cell, and is changed through the use of a resistive voltage divided or through changing the impedance using an op.amp. Voltage levels are determined based on Vss, and must maintain the relative magnitudes shown below. V0≥V1≥V2≥V3≥V4≥VSS																
23	V3																		
24	V2																		
25	V1																		
26	V0																		
27	C86	I	This is the MPU interface switch terminal C86="H" : 6800 series MPU interface C86="L" : 8080 MPU interface																
28	P/S	I	This pin configures the interface to be parallel mode or serial mode. P/S = "H": Parallel data input/output. P/S = "L": Serial data input. The following applies depending on the P/S status:																
				<table border="1"> <thead> <tr> <th>P/S</th> <th>Data/Command</th> <th>Data</th> <th>Read/Write</th> <th>4-lineSPI Clock</th> </tr> </thead> <tbody> <tr> <td>"H"</td> <td>A0</td> <td>D0 to D7</td> <td>/RD, /WR</td> <td>x</td> </tr> <tr> <td>"L"</td> <td>A0</td> <td>SI (D7)</td> <td>Write only</td> <td>SCL (D6)</td> </tr> </tbody> </table>	P/S	Data/Command	Data	Read/Write	4-lineSPI Clock	"H"	A0	D0 to D7	/RD, /WR	x	"L"	A0	SI (D7)	Write only	SCL (D6)
				P/S	Data/Command	Data	Read/Write	4-lineSPI Clock											
"H"	A0	D0 to D7	/RD, /WR	x															
"L"	A0	SI (D7)	Write only	SCL (D6)															
When P/S = "L", D0 to D5 must be fixed to "H". /RD (E) and /WR (R/W) are fixed to either "H" or "L". The serial access mode does NOT support read operation.																			

A	Supply voltage for backlight LED+
K	Supply voltage for backlight LED-

6. ABSOLUTE MAXIMUM RATINGS

Parameter	Symbol	Conditions	Unit
Power Supply Voltage	VDD	-0.3 ~ 3.6	V
Power supply voltage (VDD standard)	V0, VOUT	-0.3 ~ 13.5	V
Power supply voltage (VDD standard)	V1, V2, V3, V4	-0.3 to V0	V
Operating temperature	TOPR	-20 to +70	°C
Storage temperature	TSTR	-30 to +80	°C

7. BACKLIGHT CHARACTERISTICS

Item	Symbol	min.	typ.	max.	Unit	Condition
Forward Voltage	Vf	2.6	3.0	3.3	V	If= 60 mA
Power Dissipation	Pd	156	180	204	mW	If= 60 mA
Luminous Uniformity	$\Delta Lv$	70			%	MIN/MAX*100%
Luminance	Lv		250		cd/m <sup>2</sup>	If= 60 mA T=25°C
Color Coordinate	X	0.240		0.330		
	Y	0.240		0.330		
Peak wave length	$\lambda P$	-	-	-	nm	

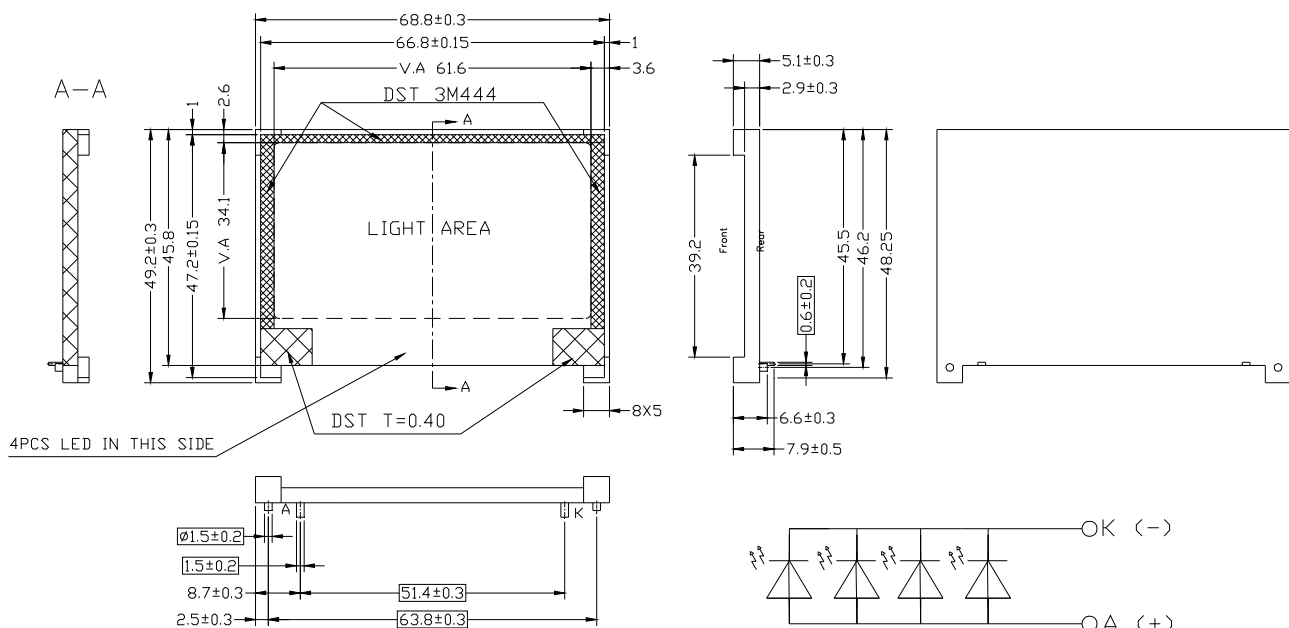

Remarks:  
 1. Unmarked tolerance is ±0.20;  
 2. All material comply with RoHs.



8. ELECTRICAL CHARACTERISTICS

8.1. DC CHARACTERISTICS

Item	Symbol	Condition	STANDARD VALUE			units
			Min.	Typ.	Max.	
Operating Voltage	V <sub>DD</sub>	Relative to VSS	2.7	3.0	3.3	V
LCD driving voltage	V <sub>LCD</sub>	Relative to VSS	9.6	9.8	10	
Consumption current	I <sub>DD</sub>	-	-	t.b.d.	-	mA

8.2. AC CHARACTERISTICS

System Bus Read/Write Characteristics 1 (For the 8080 Series MPU)

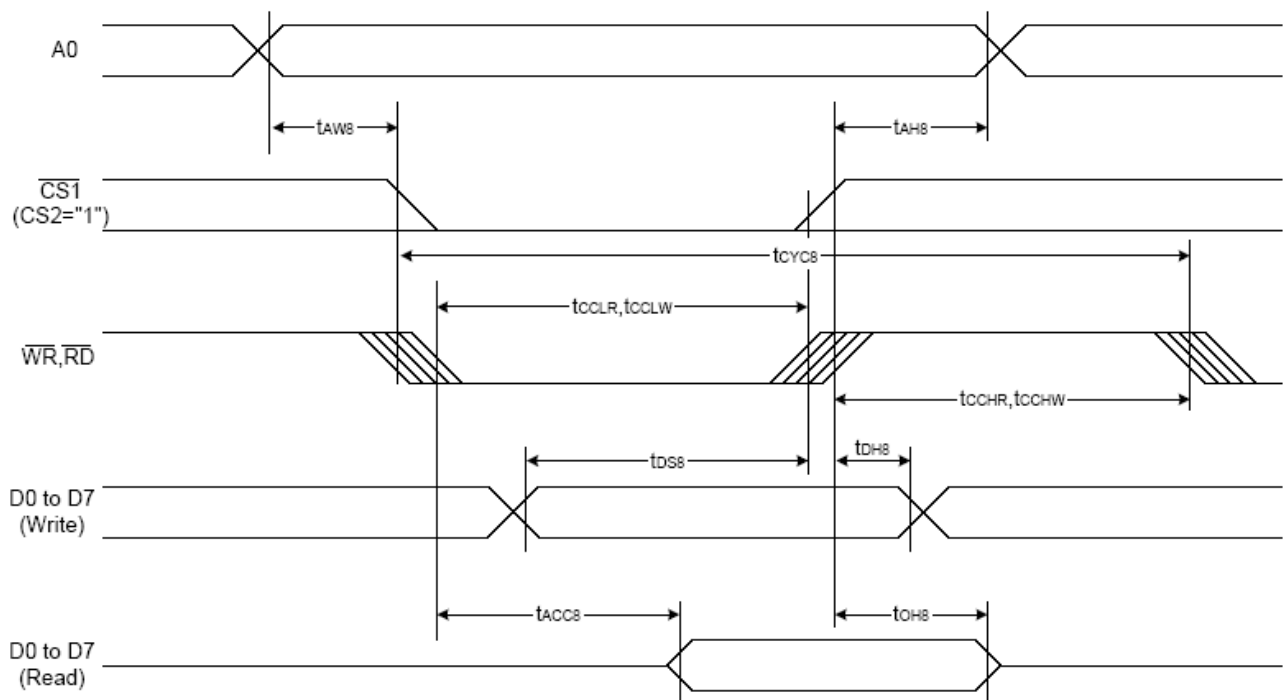

(V<sub>DD</sub>=3.0V T<sub>A</sub>=25°C)

Item	Signal	Symbol	Condition	Rating		Units
				Min.	Max.	
Address hold time	A0	t <sub>AH8</sub>		0	—	Ns
Address setup time		t <sub>AW8</sub>		0	—	
System cycle time		t <sub>CYC8</sub>		240	—	
Enable L pulse width (WRITE)	WR	t <sub>CCLW</sub>		80	—	
Enable H pulse width (WRITE)		t <sub>CCHW</sub>		80	—	
Enable L pulse width (READ)	RD	t <sub>CCLR</sub>		140	—	
Enable H pulse width (READ)		t <sub>CCHR</sub>		80	—	
WRITE Data setup time	D0 to D7	t <sub>DS8</sub>		40	—	
WRITE Address hold time		t <sub>DH8</sub>		0	—	
READ access time		t <sub>ACC8</sub>	CL = 100 pF	—	70	
READ Output disable time		t <sub>OH8</sub>	CL = 100 pF	5	50	

System Bus Read/Write Characteristics 2 (For the 6800 Series MPU)

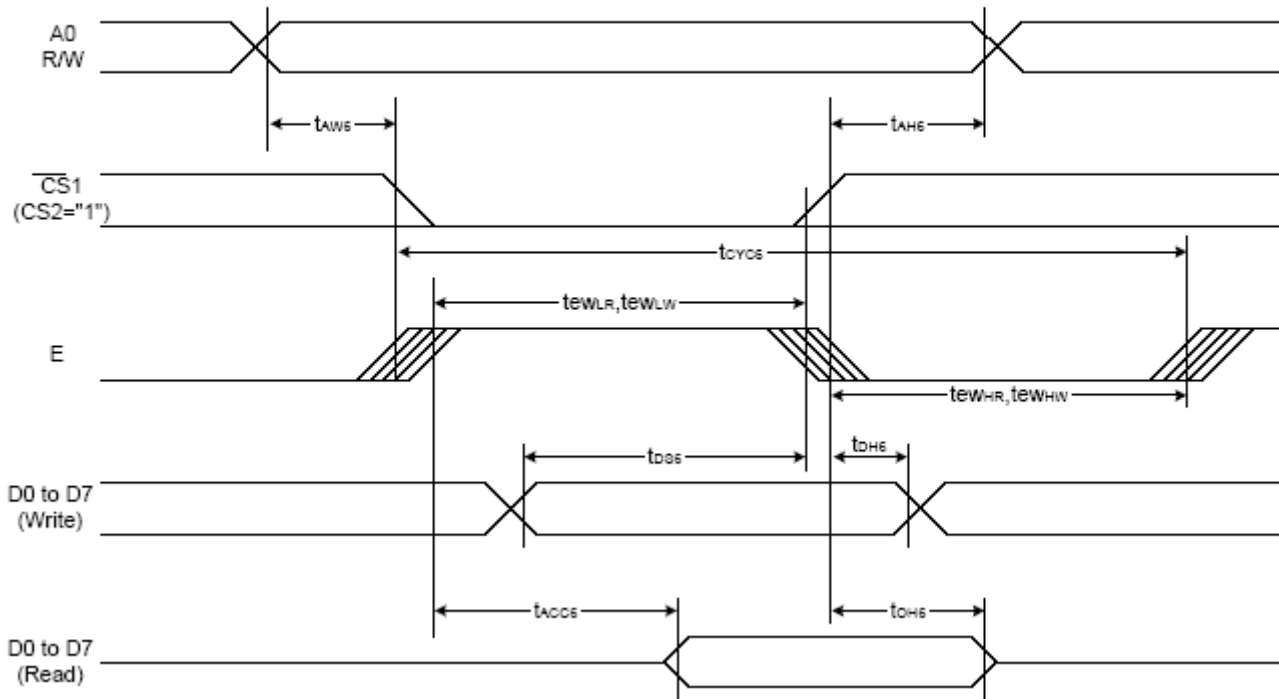

(V<sub>DD</sub>=3.0V T<sub>A</sub>=25°C)

Item	Signal	Symbol	Condition	Rating		Units
				Min.	Max.	
Address hold time	A0	t <sub>AHS</sub>		0	—	ns
Address setup time		t <sub>AWS</sub>		0	—	
System cycle time		t <sub>CYCS</sub>		240	—	
Enable L pulse width (WRITE)	WR	t <sub>EHLW</sub>		80	—	
Enable H pulse width (WRITE)		t <sub>EHW</sub>		80	—	
Enable L pulse width (READ)	RD	t <sub>EHLR</sub>		80	—	
Enable H pulse width (READ)		t <sub>EHR</sub>		140	—	
WRITE Data setup time	D0 to D7	t <sub>DS6</sub>		40	—	
WRITE Address hold time		t <sub>DHS</sub>		0	—	
READ access time		t <sub>ACC6</sub>	CL = 100 pF	—	70	
READ Output disable time		t <sub>OHS</sub>	CL = 100 pF	5	50	

The 4-line SPI Interface

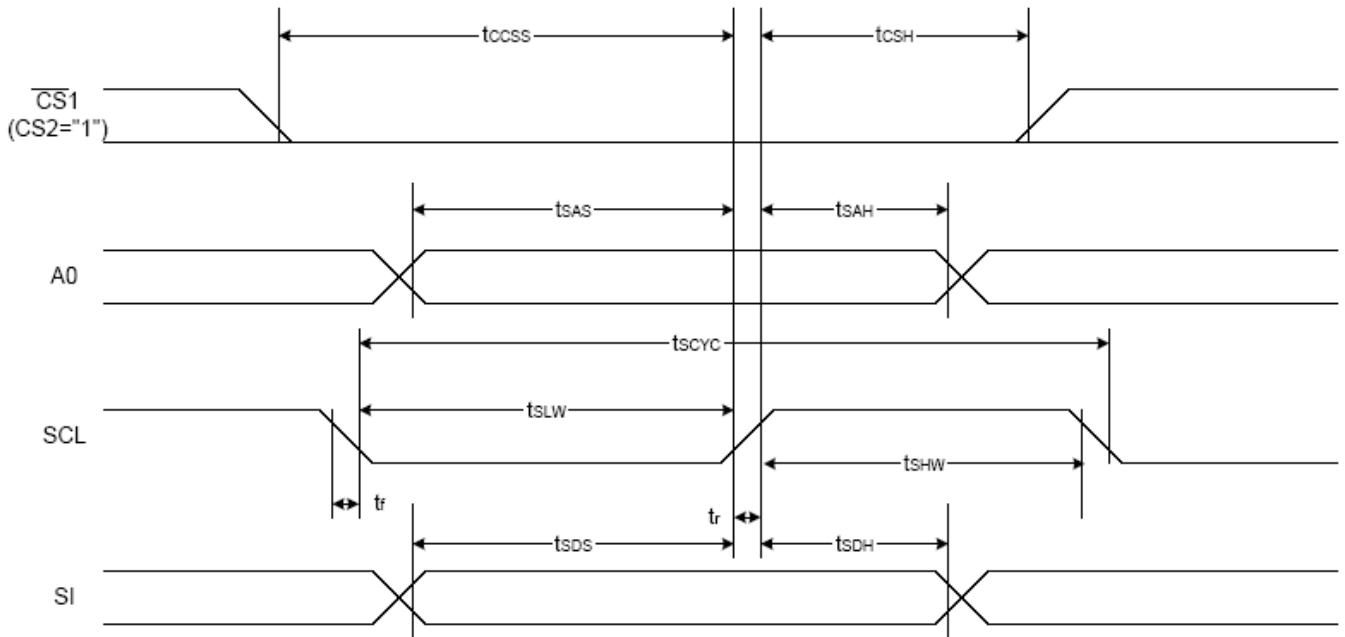

( $V_{DD}=3.0V$   $T_A=25^\circ C$ )

Item	Signal	Symbol	Condition	Rating		Units
				Min.	Max.	
4-line SPI Clock Period	SCL	$T_{scyc}$		50	—	ns
SCL "H" pulse width		$T_{shw}$		25	—	
SCL "L" pulse width		$T_{sLW}$		25	—	
Address setup time	A0	$T_{sAS}$		20	—	
Address hold time		$T_{sah}$		10	—	
Data setup time	SI	$T_{sds}$		20	—	
Data hold time		$T_{sDH}$		10	—	
CS-SCL time	CS	$T_{css}$		20	—	
CS-SCL time		$T_{csh}$		40	—	

Reset Timing

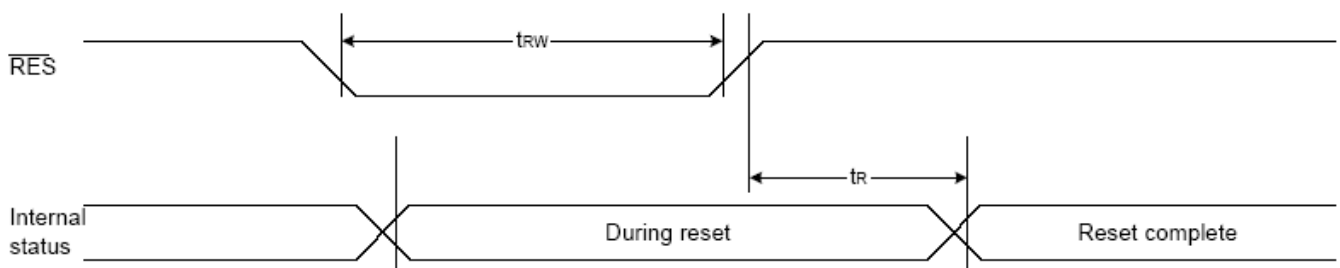

Item	Signal	Symbol	Condition	Rating			Units
				Min.	Typ.	Max.	
Reset time		$t_r$		—	—	1.0	us
Reset "L" pulse width	$\overline{RES}$	$t_{rw}$		1.0	—	—	us

## 9. COMMAND TABLE

(COMMAND FOR ST7565R)

Command	Command Code									Function				
	A0	/RD	/WR	D7	D6	D5	D4	D3	D2		D1	D0		
(1) Display ON/OFF	0	1	0	1	0	1	0	1	1	1	0	1	LCD display ON/OFF 0: OFF, 1: ON	
(2) Display start line set	0	1	0	0	1	Display start address					0	1	Sets the display RAM display start line address	
(3) Page address set	0	1	0	1	0	1	1	Page address				0	1	Sets the display RAM page address
(4) Column address set upper bit	0	1	0	0	0	0	1	Most significant column address				0	1	Sets the most significant 4 bits of the display RAM column address. Sets the least significant 4 bits of the display RAM column address.
Column address set lower bit				0	0	0	0	Least significant column address				0	1	
(5) Status read	0	0	1	Status				0	0	0	0	0	Reads the status data	
(6) Display data write	1	1	0	Write data							0	1	Writes to the display RAM	
(7) Display data read	1	0	1	Read data							0	1	Reads from the display RAM	
(8) ADC select	0	1	0	1	0	1	0	0	0	0	0	0	1	Sets the display RAM address SEG output correspondence 0: normal, 1: reverse
(9) Display normal/reverse	0	1	0	1	0	1	0	0	1	1	0	0	1	Sets the LCD display normal/ reverse 0: normal, 1: reverse
(10) Display all points ON/OFF	0	1	0	1	0	1	0	0	1	0	0	0	1	Display all points 0: normal display 1: all points ON
(11) LCD bias set	0	1	0	1	0	1	0	0	0	1	0	0	1	Sets the LCD drive voltage bias ratio 0: 1/9 bias, 1: 1/7 bias (ST7565R)
(12) Read-modify-write	0	1	0	1	1	1	0	0	0	0	0	0	0	Column address increment At write: +1 At read: 0
(13) End	0	1	0	1	1	1	0	1	1	1	0	0	0	Clear read/modify/write
(14) Reset	0	1	0	1	1	1	0	0	0	1	0	0	0	Internal reset
(15) Common output mode select	0	1	0	1	1	0	0	0	*	*	*	1	*	Select COM output scan direction 0: normal direction 1: reverse direction
(16) Power control set	0	1	0	0	0	1	0	1	Operating mode		0	1	0	Select internal power supply operating mode
(17) V <sub>0</sub> voltage regulator internal resistor ratio set	0	1	0	0	0	1	0	0	Resistor ratio		0	1	0	Select internal resistor ratio(Rb/Ra) mode
(18) Electronic volume mode set	0	1	0	1	0	0	0	0	0	0	0	0	1	Set the V <sub>0</sub> output voltage electronic volume register
Electronic volume register set				0	0	Electronic volume value					0	1		
(19) Static indicator ON/OFF	0	1	0	1	0	1	0	1	1	0	0	0	0	0: OFF, 1: ON
Static indicator register set				0	0	0	0	0	0	0	0	0	0	0
(20) Booster ratio set	0	1	0	1	1	1	1	1	1	0	0	0	0	select booster ratio 00: 2x,3x,4x 01: 5x 11: 6x
(21) Power save	0	1	0								0	1	Display OFF and display all points ON compound command	
(22) NOP	0	1	0	1	1	1	0	0	0	0	1	1	0	Command for non-operation
(23) Test	0	1	0	1	1	1	1	*	*	*	*	*	*	Command for IC test. Do not use this command

10. LCD ARTWORK

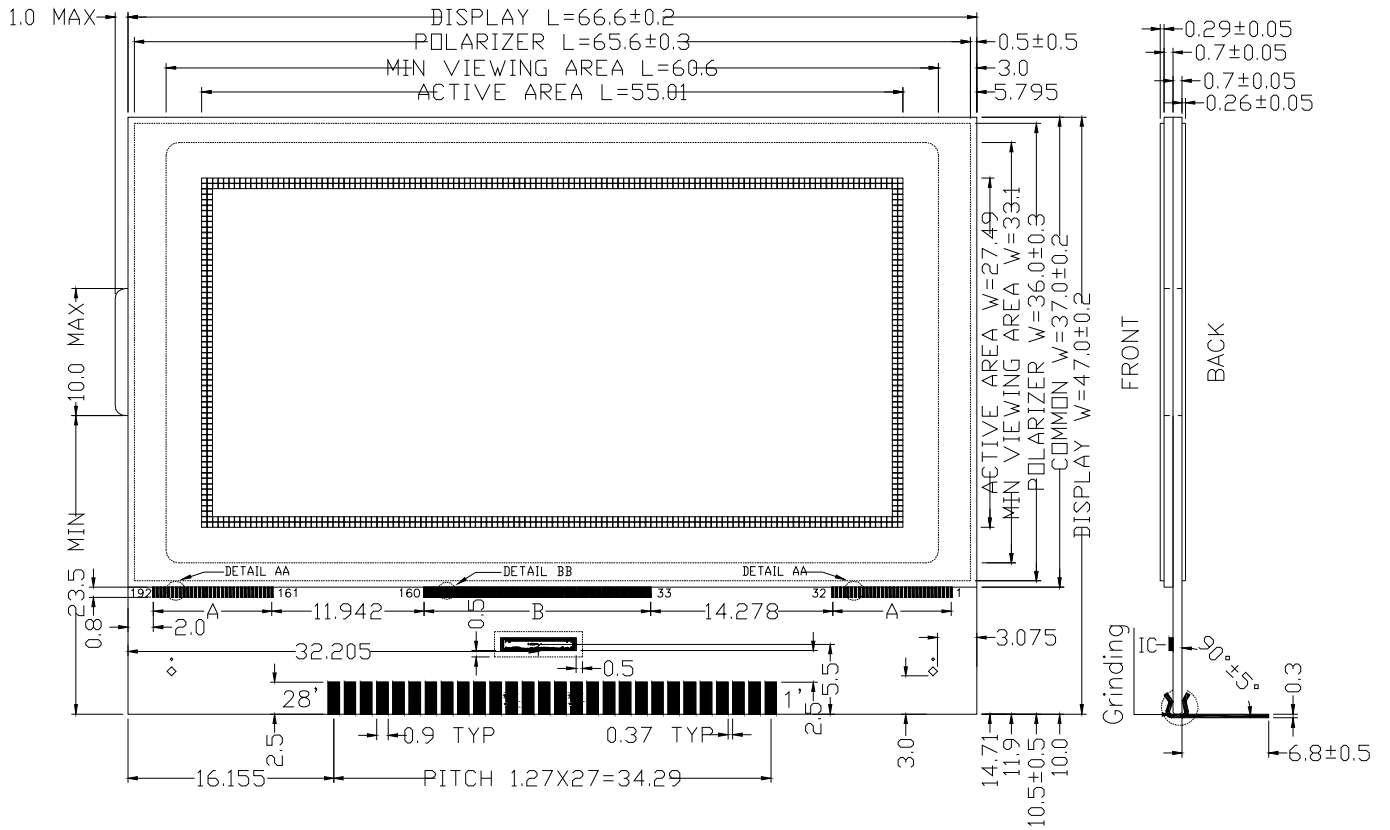

11. LCD LABELING

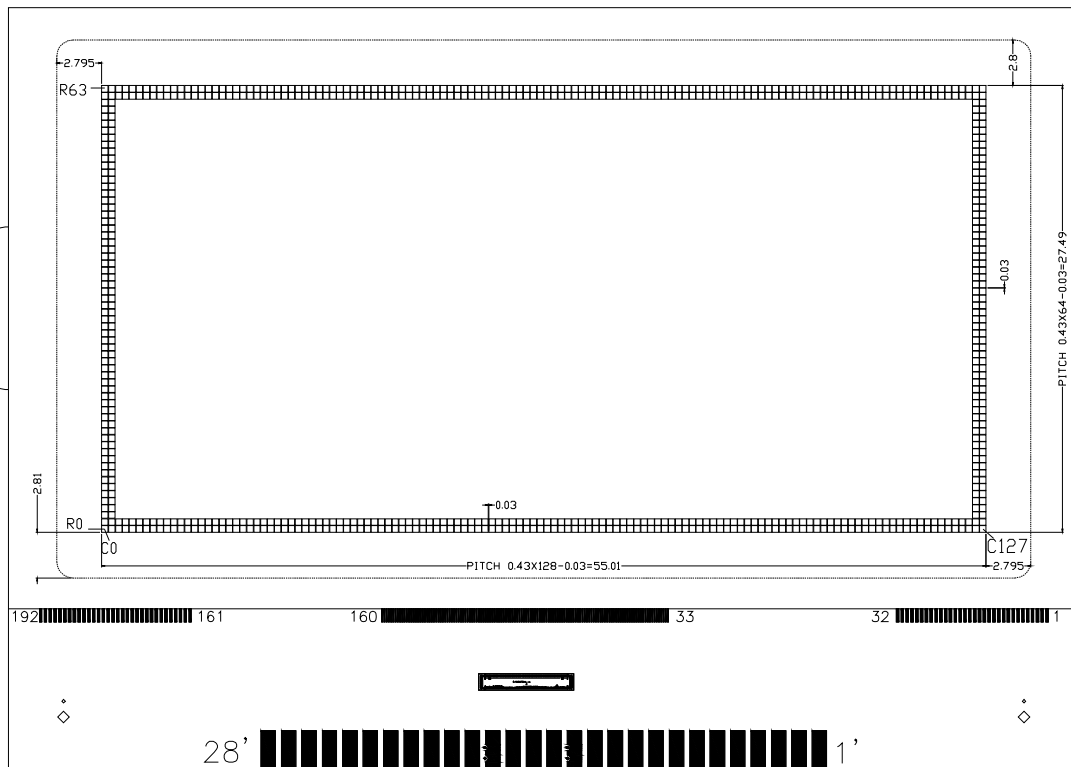

12. SEG LAYOUT

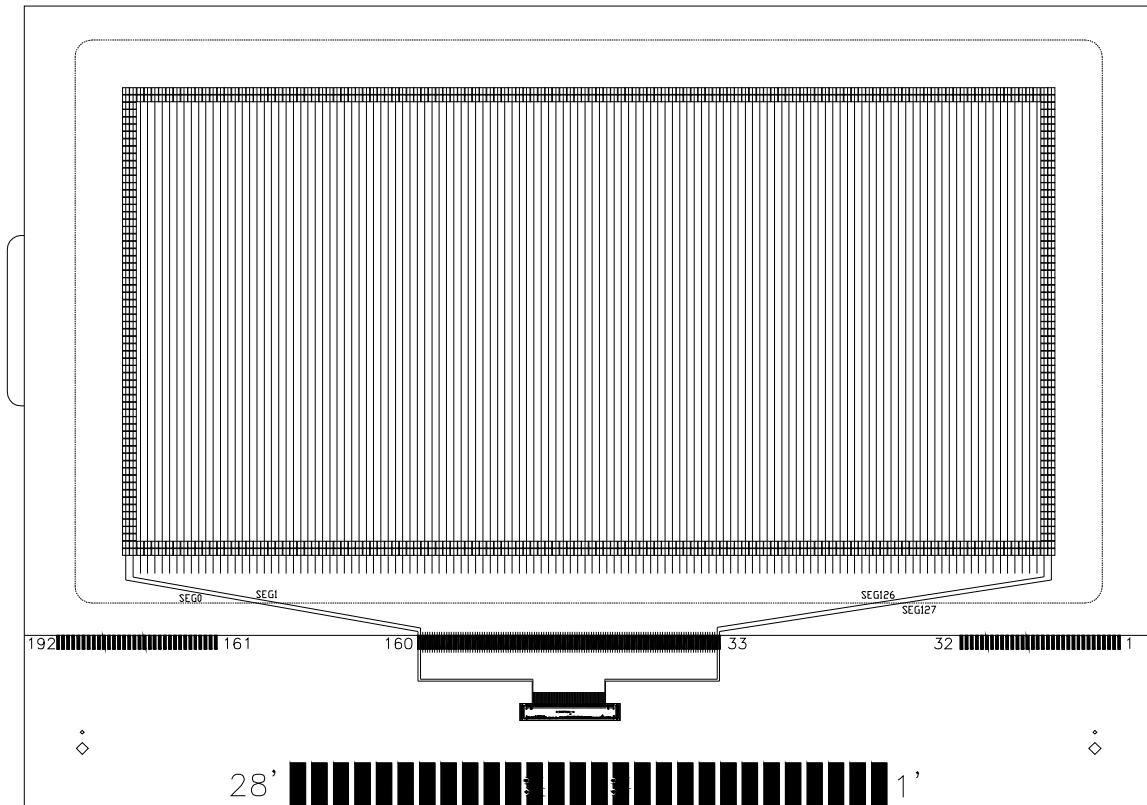

13 COM LAYOUT

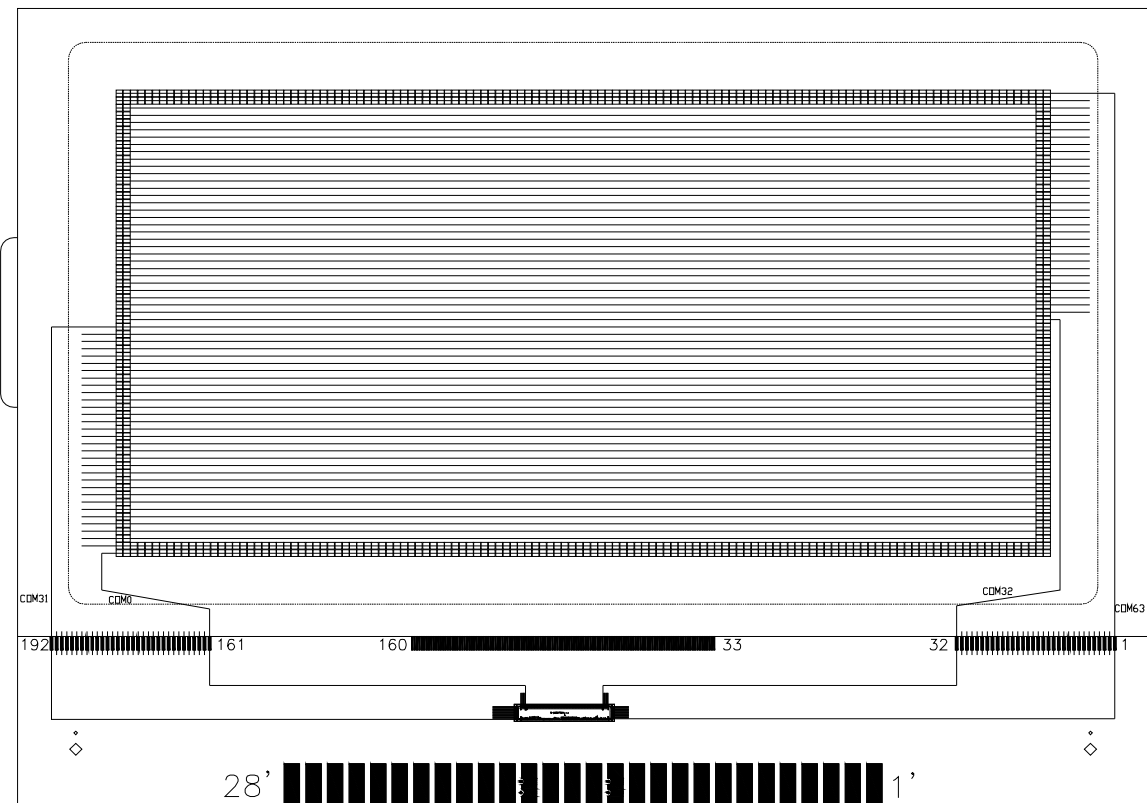

**14. PAD CONFIGURATION GRAPHIC DIMENSION**

PAD NO.	IC NO.	PAD CONFIGURATION
1	COM63	COM63[R63<C0-C127>]
2	COM62	COM62[R62<C0-C127>]
31	COM33	COM33[R33<C0-C127>]
32	COM32	COM32[R32<C0-C127>]
33	SEG127	SEG127[C127<R0-R63>]
34	SEG126	SEG126[C126<R0-R63>]
159	SEG1	SEG1[C1<R0-R63>]
160	SEG0	SEG0[C0<R0-R63>]
161	COM0	COM0[R0<C0-C127>]
162	COM1	COM1[R1<C0-C127>]
191	COM30	COM30[R30<C0-C127>]
192	COM31	COM31[R31<C0-C127>]

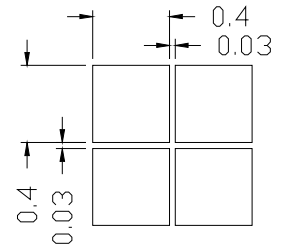

**15. IC LAYOUT**

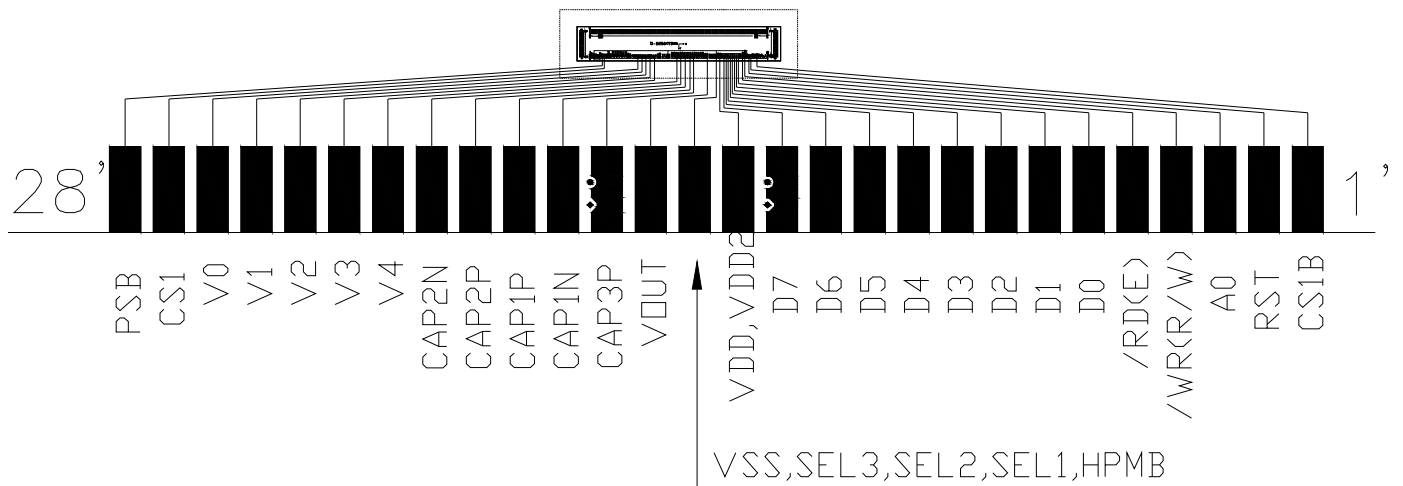

16. QUALITY DESCRIPTION

DEFECT SPECIFICATION:

Specific type-related items are covered in this sheet.

- a: Table for Cosmetic defects  
(Note: nc = not counted).  
Sizes and number of defects  
(Max. Qty)

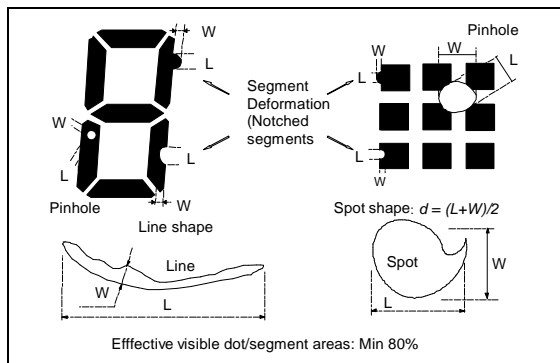

Defect Type	Max. defect size [mm] d or L	W	Max. Quantity.	
Black or White Spots	$d \leq 150$		nc	
	$150 < d \leq 300$		5	
Black or White Lines	--	$W \leq 10$	nc	
		$L \leq 5000$	$W \leq 30$	3
		$L \leq 2000$	$W \leq 50$	2
Pinhole	$d \leq 150$		nc	
	$150 < d \leq 300$		1/segment	
(Total defects)			(5)	
Segment Deformation		$W \leq 100$	nc	
Bubble (e.g. under pola)	$d \leq 150$		nc	
	$200 < d \leq 400$		3	
	$400 < d \leq 600$		1	

Examples/ Shapes

- b: Glass defects
- b1: Glass defects at contact ledge

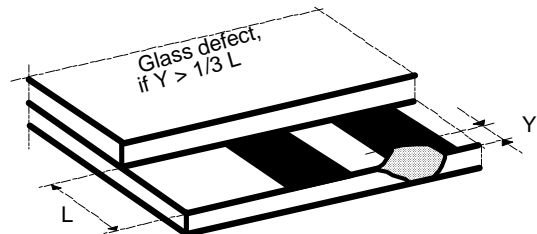

- b2: Glass chipping in other areas shall not be in conflict with the product's function.



**17. MODULE ACCEPTS QUALITY LEVEL (AQL).**

**17.1. AQL standard value: Fatal defect =0.1, Major defect=0.65; Minor defect =2.5.**

**17.2. Curtailed inspection scheme**

Type	Batch Qty	inspection Qty	AQL value	pass	Reject
Module Product	350PCS < 1000PCS	125pcs	0.1	0	1
			0.65	2	3
			2.5	7	8
	200PCS < 350PCS	80pcs	0.1	0	1
			0.65	1	2
			2.5	5	6
	<200PCS	32pcs	0.1	0	1
			0.65	0	1
			2.5	4	5
Module Sample	<200PCS	All inspected	/	/	The sample will be reject when the fatal defect > 2pcs or main defect > 5pcs.
	>200PCS	125pcs			

- Notes:** 1). Batch QTY is the production amount that production department ship to QA department.  
 2). All of productions will be inspected if the batch QTY less than inspected QTY.  
 3). Each batch fixed to be 500pcs.

**18. RELIABILITY TEST**

Operating life time: Longer than 50000 hours  
 (at room temperature without direct irradiation of sunlight)

Reliability characteristics shall meet following requirements.

TEMPERATURE TESTS	NORMAL GRADE
High Temperature Storage	+80°C x 96HR
Low Temperature Storage	-30°C x 96HR
High Temperature Operation	+70°C x 96HR
Low Temperature Operation	-20°C x 96HR
High Temperature, High Humidity	+60°C 90%RH 96HR
Thermal Shock	-20°C x 30 min ← 10s ↓ 5Cycles 70°C x 30 min →
Vibration Test	Frequency x Swing x Time 40Hz x 4mm x 4hrs
Drop Test	Drop height x Times 1.0m x 6 times

**19. LCD MODULES HANDLING PRECAUTIONS**

- n The display panel is made of glass. Do not subject it to a mechanical shock by dropping it from a high place, etc.
- n If the display panel is damaged and the liquid crystal substance inside it leaks out, do not get any in your mouth. If the substance come into contact with your skin or clothes promptly wash it off using soap and water.
- n Do not apply excessive force to the display surface or the adjoining areas since this may cause the color tone to vary.
- n The polarizer covering the display surface of the LCD module is soft and easily scratched. Handle this polarize carefully.
- n To prevent destruction of the elements by static electricity, be careful to maintain an optimum work environment.
  - Be sure to ground the body when handling the LCD module.
  - Tools required for assembly, such as soldering irons, must be properly grounded.
  - To reduce the amount of static electricity generated, do not conduct assembly and other work under dry conditions.
  - The LCD module is coated with a film to protect the display surface. Exercise care when peeling off this protective film since static electricity may be generated.
- n Storage precautions  
When storing the LCD modules, avoid exposure to direct sunlight or to the light of fluorescent lamps. Keep the modules in bags designed to prevent static electricity charging under low temperature / normal humidity conditions (avoid high temperature / high humidity and low temperatures below -20°C). Whenever possible, the LCD modules should be stored in the same conditions in which they were shipped from our company.

**20. OTHERS**

- n Liquid crystals solidify at low temperature (below the storage temperature range) leading to defective orientation of liquid crystal or the generation of air bubbles (black or white). Air bubbles may also be generated if the module is subjected to a strong shock at a low temperature.
- n If the LCD modules have been operating for a long time showing the same display patterns may remain on the screen as ghost images and a slight contrast irregularity may also appear. Abnormal operating status can be resumed to be normal condition by suspending use for some time. It should be noted that this phenomena does not adversely affect performance reliability.
- n To minimize the performance degradation of the LCD modules resulting from caused by static electricity, etc. exercise care to avoid holding the following sections when handling the modules:
  - Exposed area of the printed circuit board
  - Terminal electrode sections