

Display Elektronik GmbH

DATA SHEET

LCD STANDARD PANEL

DE 122 - SERIES

Product specification

Version : 1

27.01.2005

GENERAL SPECIFICATION

MODULE NO. :

DE 122 - SERIES

CUSTOMER P/N

VERSION NO.	CHANGE DESCRIPTION	DATE
0	ORIGINAL VERSION	06.12.2001
1	CHANGED MODEL TYPES	27.01.2005

PREPARED BY: MHO
APPROVED BY: MH

DATE: 27.01.2005
DATE: 27.01.2005

CONTENTS

1. GENERAL FEATURES-----2

2. ORDERING INFORMATION-----2

3. MODEL TYPES-----2

4. MECHANICAL SPECIFICATIONS-----3

5. PIN ASSIGNMENT-----3

6. ELECTRICAL AND PHYSICAL PROPERTIES-----4

7. APPLICATION NOTE-----4

8. SEGMENT DEFINITION-----4

9. CONNECTING LCDs-----5

10. SOLDER CONDITIONS FOR LCD WITH FIXED PINS-----5

11. CLEANING OF LCDs-----5

12. HANDLING PRECAUTIONS-----5

1. GENERAL FEATURES

Display Elektronik GmbH is specialized in LCD-products.

- There is a wide range of standard lcd-panels. Most of them are available from stock.
- Most of our standard panels operate within the extended temperature range (-20°C to +70°C).
- For the static types the Vlcd is ready for 3 Volt, like shown in the following table. For most of our multiplexed standard panels we offer a 3Volt and a 5Volt model.
- Most panels are available in reflective and transfective version.
- In general we offer a standard pinlength from stock. Pls ask us in case you want a different pinlength. For the LCD-panels without pins we also offer elastomeric connectors (zebras).
- For outdoor applications we offer suitable LCD-displays with extreme wide temperature range and UV-stability etc...

2. ORDERING INFORMATION

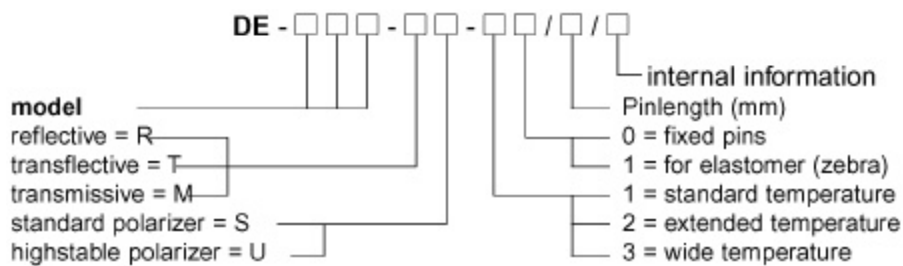

Example:

DE-113-RS-10/7,5
 LCD 3½ digits
 Digit height 12.7 mm
 Reflective
 Standard polarizer
 Standard temperature
 Fixed pins
 Pinlength 7.5 mm

3. MODEL TYPES

Our actual model types are:

MODEL NAME	POLARIZER MODE	POLARIZER TYPE	OPERATING TEMPERATURE	PIN LENGTH	VIEWING DIRECTION	OPERATING VOLTAGE	VOLTAGE MODE
DE 122-RS-20/6,35	reflective	standard	-20°C ... +70°C	6,35	6° clock	3-5 Volt	static
DE 122-TU-20/12,2	transflective	high-stabile	-20°C ... +70°C	12,2	6° clock	3-5 Volt	static

4. MECHANICAL SPECIFICATIONS

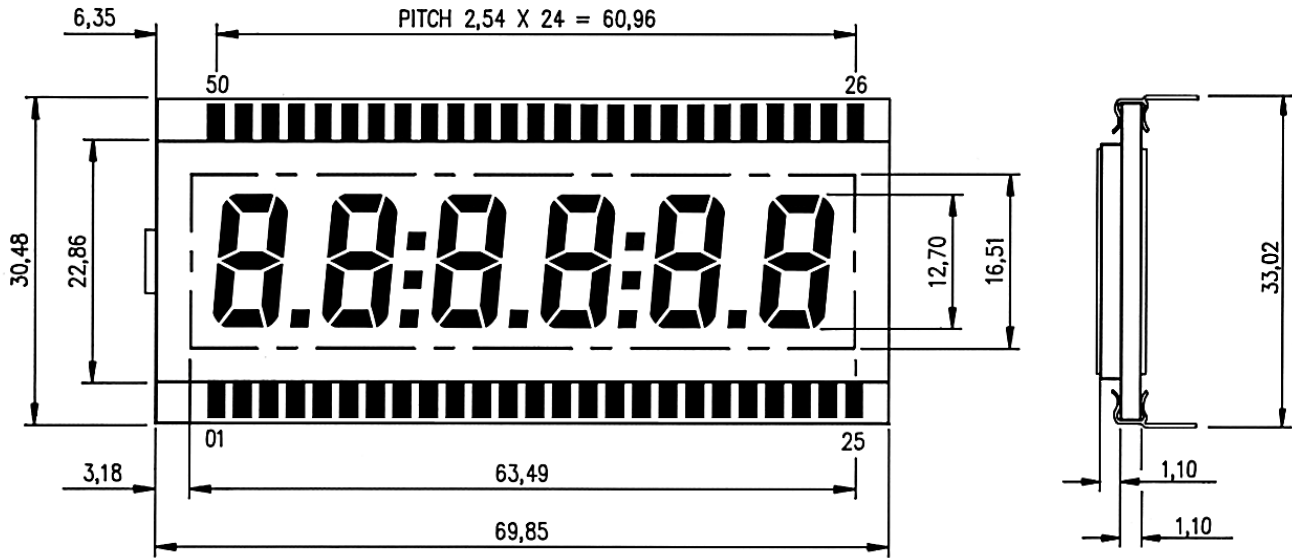

5. PIN ASSIGNMENT

SEG.	6A	6F	6G	5B	5A	5F	5G	COL2	4B	4A	4F	4G	3B	3A	3F	3G	COL1	2B	2A	2F	2G	1B	1A	1F	1G
PIN#	26	27	28	29	30	31	32	33	34	35	36	37	38	39	40	41	42	43	44	45	46	47	48	49	50
SEG.	BP	1E	1D	1C	DP1	2E	2D	2C	DP2	3E	3D	3C	DP3	4E	4D	4C	DP4	5E	5D	5C	DP5	6E	6D	6C	6B
PIN#	1	2	3	4	5	6	7	8	9	10	11	12	13	14	15	16	17	18	19	20	21	22	23	24	25

6. ELECTRICAL AND PHYSICAL PROPERTIES

At an ambient temperature of 25°C	Standard temperature			Extended temperature			Wide temperature			Unit
	min.	typ.	max.	min.	typ.	max.	min.	typ.	max.	
Operating voltage		3			3			5		V
Driving frequency	30	32	100	30	32	100	30	32	100	Hz
Current consumption		1,0	2,0		1,0	2,0		1,0	2,0	µA/cm ²
DC-voltage allowance			50			50			50	mV
Response time (t _{on} + t _{off})		440			440				450	ms
Operating temperature	-10		60	-20		70	-40		90	°C
Storage temperature	-20		65	-40		90	-40		90	°C
Lifetime	100 000									h

7. APPLICATION NOTE

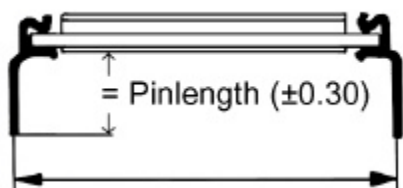

Distance of pinrow to pinrow
= glass-size +2.54 mm

DIL-Pins

Pinlength = Distance
between rear side of
LCD to end of pin

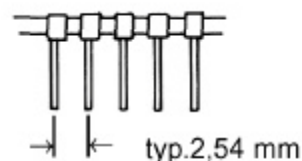

Ø hole in PCB typ. 1,0 mm

8. SEGMENT DEFINITION

7 SEGMENT

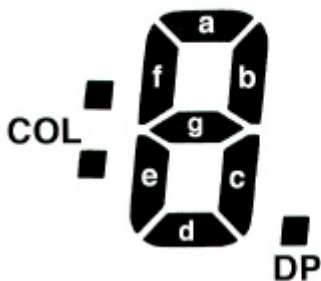

14 SEGMENT

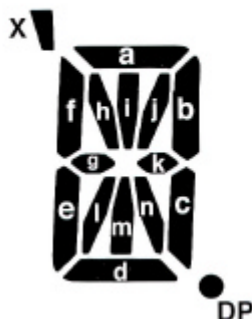

16 SEGMENT



MUX-LCDs
Typical organisation
of triplex driving

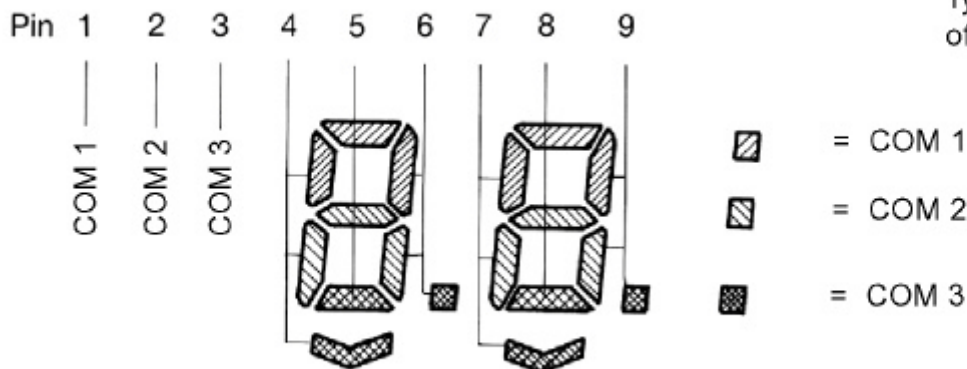

Digits to be counted from left to right.

9. CONNECTING LCDs

- Fixed pins have a typical pitch of 2,54mm. (Pls refer to mechanical specification).
- LCD for elastomeric connectors (zebras) may have thighter pitches. Please regard tolerances and pitch of elastomer connector.

10. SOLDER CONDITIONS FOR LCD WITH FIXED PINS

	min.	typ.	max.
Solder temperature	t.b.d.	~ 235°C	260°C
Solder duration	t.b.d.	2 seconds	5 seconds
Distance to glass substrate	4mm	6mm	t.b.d.

t.b.d. – to be discussed !

11. CLEANING OF LCDs

- LCDs have a protective foil on top of the front glass. This foil should be removed at the latest possible stage.
- If there is a need of cleaning, you may use freon or alcohol with a soft fabric, as front polarizers are sensitive to physical damage.
- Pls also note this protective foil on the rear side, in case you use transfective model-types.
- Do not use ultrasonic for cleaning of PCB once LCD is soldered.

12. HANDLING PRECAUTIONS

- As polarizers of LCD (front and rear-side) are sensitive, they must be handled with care.
- DC Voltage or drive voltage higher than specified voltage will decrease the lifetime of the liquid crystal display panel.
- If any fluid leaks out of a damaged glass cell, wash off any human part that comes into contact with soap and water. Never swallow the fluid. The toxicity is low, but caution should exercised at all times.
- LCD is made up of glass, organic sealant, organic fluid and polymer based polarizers. The following precautions should be taken when handling:
Keep the temperature within range for use and storage. Excessive temperature and humidity could cause polarization degredation, polarizer peel-off or bubble generation. When storage for a long period over 40°C is required, the relative humidity should be kept below 60%.