

Display Elektronik GmbH

DATA SHEET

TFT- MODULE

DEM 800600F TMH-PW-N

10,4" TFT

15.05.2012

Revise Records

| Rev. | Date | Contents | Written | Approved |
|------|------------|---------------------------|---------|----------|
| 0 | 15.05.2012 | Preliminary Specification | MH | |
| | | | | |
| | | | | |
| | | | | |
| | | | | |
| | | | | |
| | | | | |
| | | | | |
| | | | | |
| | | | | |
| | | | | |
| | | | | |

Special Notes

| | |
|--------|--|
| Note1. | |
| Note2. | |
| Note3. | |
| Note4. | |
| Note5. | |
| | |
| | |
| | |
| | |
| | |
| | |
| | |
| | |
| | |
| | |
| | |
| | |
| | |
| | |
| | |
| | |
| | |
| | |
| | |

Contents

| | | |
|-----|-------------------------------------|----|
| 1. | General Description and Features | 4 |
| 1.1 | Features | 4 |
| 1.2 | LCD Module | 4 |
| 2. | Mechanical Information | 4 |
| 3. | Electrical Specifications | 5 |
| 3.1 | Absolute Max. Ratings | 5 |
| 3.2 | Power on/off sequence | 7 |
| 3.3 | AC Timing Characteristic of The LCD | 8 |
| 3.4 | Back-Light Unit | 10 |
| 4. | Optical Characteristics | 11 |
| 4.1 | Optical characteristic of the LCD | 11 |
| 5. | I/O Terminal | 13 |
| 5.1 | Pin Assignment | 13 |
| 5.2 | Back Light Unit | 14 |
| 5.3 | Block Diagram | 15 |
| 6. | Displayed Color and Input Data | 16 |
| 7. | Reliability Condition | 17 |
| 8. | Dimensional Outlines | 18 |
| 9. | Incoming Inspection Standards | 19 |

1. General Description and Features

DEM 800600F TMH-PW-N is a transmissive type color active matrix TFT (Thin Film Transistor) liquid crystal display (LCD) that uses amorphous silicon TFT as a switching device. This model is composed of a TFT-LCD module and a back-light unit. Graphics and texts can be displayed on a SVGA 800 (W) x RGB x 600 (H) dots (4:3 aspect ratio) with 16.2M colors by supplying 24 bits data signal (8bits/each color). The following table described the features of DEM 800600F TMH-PW-N.

1.1 Features

- Transmissive and LED Backlight with 30 LEDs.
- TN (Twisted Nematic) mode.
- ROHS Compliance
- High Brightness

1.2 LCD Module

| Item | Specification | Unit |
|--------------------|---|----------|
| Screen Size | 10.4 inches | Diagonal |
| Display Resolution | 800 (H) x 600 (V) | Pixel |
| Active Area | 211.2 (H) x 158.4 (V) | mm |
| Outline Dimension | 243 (H) x 185.6 (V) x 7.3 (T) | mm |
| Display Mode | Normally white mode/ Transmissive | -- |
| Pixel Arrangement | R,G,B Vertical Stripe | -- |
| Pixel Size | 0.264 x 0.264 | mm |
| Surface Treatment | Anti-Glare and Hard Coating(3H) | |
| Display Color | 16.2M | -- |
| Viewing Direction | 6 o'clock | -- |
| Input Interface | Digital 24 bit RGB (8bits/each color) Data Transfer | -- |

2. Mechanical Information

| Item | | Min. | Typ. | Max. | Unit | Note |
|-------------|----------------|------|-------|------|------|------|
| Module Size | Horizontal (H) | -- | 243 | -- | mm | |
| | Vertical (V) | -- | 185.6 | -- | mm | |
| | Thickness (T) | -- | 7.3 | -- | mm | (1) |
| Weight | | -- | (TBD) | -- | g | -- |

Note (1) Not Include Component. Refer to the Outline Dimension Drawing as attached.

3. Electrical Specifications

3.1 Absolute Max. Ratings

3.1.1 Absolute Ratings of Environment

If the operating condition exceeds the following absolute maximum ratings, the TFT LCD module may be damaged permanently.

($T_a=25\pm 2^\circ\text{C}$, $V_{SS}=\text{GND}=0$)

| Item | Symbol | Min. | Max. | Unit | Note |
|-----------------------|-----------|------|------|------------------|---------|
| Storage temperature | T_{STG} | -30 | 80 | $^\circ\text{C}$ | (1) |
| Operating temperature | T_{OPR} | -20 | 70 | $^\circ\text{C}$ | (1,2,3) |

Note (1) 95 % RH Max. ($40^\circ\text{C} \geq T_a$). Maximum wet-bulb temperature at 39°C or less. ($T_a > 40^\circ\text{C}$) No condensation.

Note (2) In case of below 0° , the response time of liquid crystal (LC) becomes slower and the color of panel becomes darker than normal one. Level of retardation depends on temperature, because of LC's character

Note (3) Only operation is guaranteed at operating temperature. Contrast, response time, another display quality are evaluated at $+25^\circ\text{C}$.

3.1.2 Electrical Absolute Maximum Ratings

3.1.2.1 TFT-LCD Module

($\text{GND}=0$)

| Parameter | Symbol | Min. | Max. | Unit | Remark |
|-----------------------------|--------|--------|------|------|--------|
| Power supply voltage | VCC | -0.3 | 5.0 | V | (1) |
| Analog Power Supply Voltage | AVDD | -0.5 | 15 | V | (1) |
| TFT Device on voltage | VGH | -0.3 | 42 | V | (1) |
| TFT Device off voltage | VGL | VGH-42 | 0.3 | V | (1) |

(1) Device is subject to be damaged permanently if stresses beyond those absolute maximum ratings listed above.

3.1.2.2 Backlight Unit

($V_{SS}=\text{GND}=0$)

| Parameter | Symbol | Min. | Max. | Unit | Remark |
|---------------------------|--------|------|------|------|--------|
| Current of Backlight Unit | IB | -- | 600 | mA | |
| Voltage of Backlight Unit | VB | -- | 22 | V | |

3.1.3 DC Electrical Characteristics of the TFT LCD

(Ta=25±2°C, GND=0)

| Item | Symbol | Min. | Typ. | Max. | Unit | Remark | |
|----------------------------------|---------|------|---------|------|---------|--------|--|
| Digital Power supply | VCC | 3.0 | 3.3 | 3.6 | V | | |
| Analog Power Supply Voltage | AVDD | 10.3 | 10.5 | 10.7 | V | | |
| TFT Device on voltage | VGH | - | 18 | - | V | | |
| TFT Device off voltage | VGL | - | -7 | - | V | | |
| Common Electrode Driving Voltage | VCOM | - | 4.45 | - | V | Note 1 | |
| Input Voltage for logic | H Level | VIH | 0.7xVCC | - | VCC | V | |
| | L Level | VIL | 0 | - | 0.3xVCC | V | |
| Digital Power Supply current | ICC | 24 | 30 | 45 | mA | Note 2 | |
| Analog Supply Current | IAVDD | 32 | 40 | 60 | mA | Note 2 | |

Note1: VCOM must be adjusted to optimize display quality: cross-talk, contrast ratio and etc.

Note2: fv =60Hz , Ta=25°C , Display pattern : Black pattern

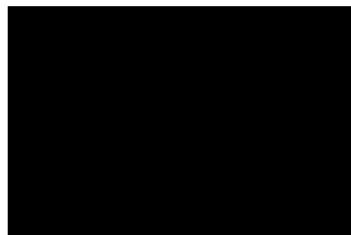

3.2 Power on/off sequence

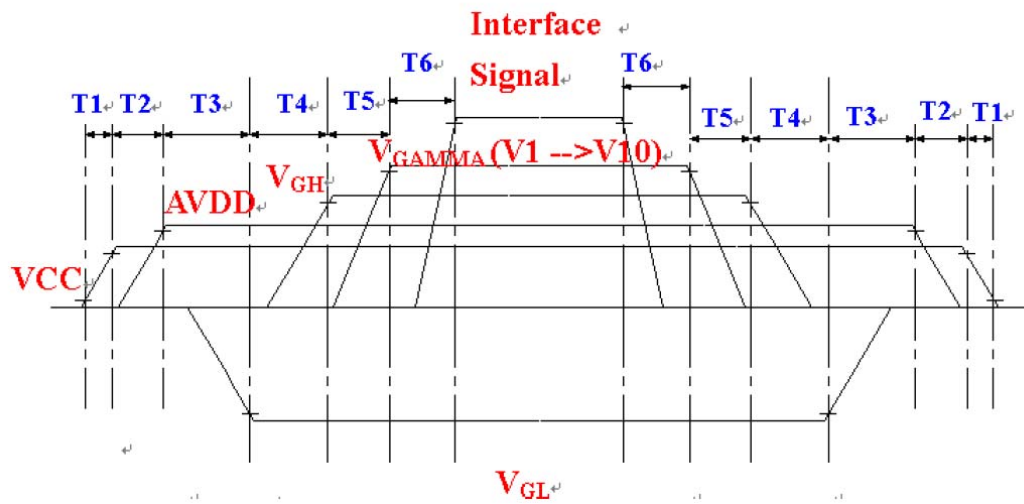

| | Min. | Typ. | Max. | Unit |
|----|------|------|------|------|
| T1 | - | - | 20 | ms |
| T2 | 16 | - | - | ms |
| T3 | > 0 | | | ms |
| T4 | >0 | | | ms |
| T5 | >0 | | | ms |
| T6 | >0 | | | ms |

3.3 AC Timing Characteristic of The LCD

3.3.1 Timing Condition

| Signal | Parameter | Symbol | Min. | Typ. | Max. | Unit. | Remark |
|-------------------|-------------------------|--------|------|------|------|-------|----------|
| DCLK | CLK frequency | fclk | - | 40 | 50 | MHz | |
| | CLK period | tclk | 20 | 25 | - | ns | |
| | CLK pulse duty | tcwh | 40 | 50 | 60 | % | |
| Horizontal Timing | One Horizontal Line | th | 862 | 1056 | 1200 | DCLK | |
| | Horizontal Display Area | thd | - | 800 | - | DCLK | |
| | HS pulse width | thpw | 1 | - | 40 | DCLK | |
| | HS Back Porch | thb | 46 | 46 | 46 | DCLK | blanking |
| | HS Front Porch | thfp | 16 | 210 | 354 | DCLK | |
| Vertical Timing | VS period time | tv | 624 | 635 | 700 | TH | |
| | Vertical Display Area | tvd | - | 600 | - | TH | |
| | VS pulse width | tvpw | 1 | - | 20 | TH | |
| | VS Back Porch | tvb | 23 | 23 | 23 | TH | blanking |
| | VS Front Porch | tvfp | 1 | 12 | 77 | TH | |

3.3.2 Timing Characteristic

3.3.2.1 Horizontal Timing

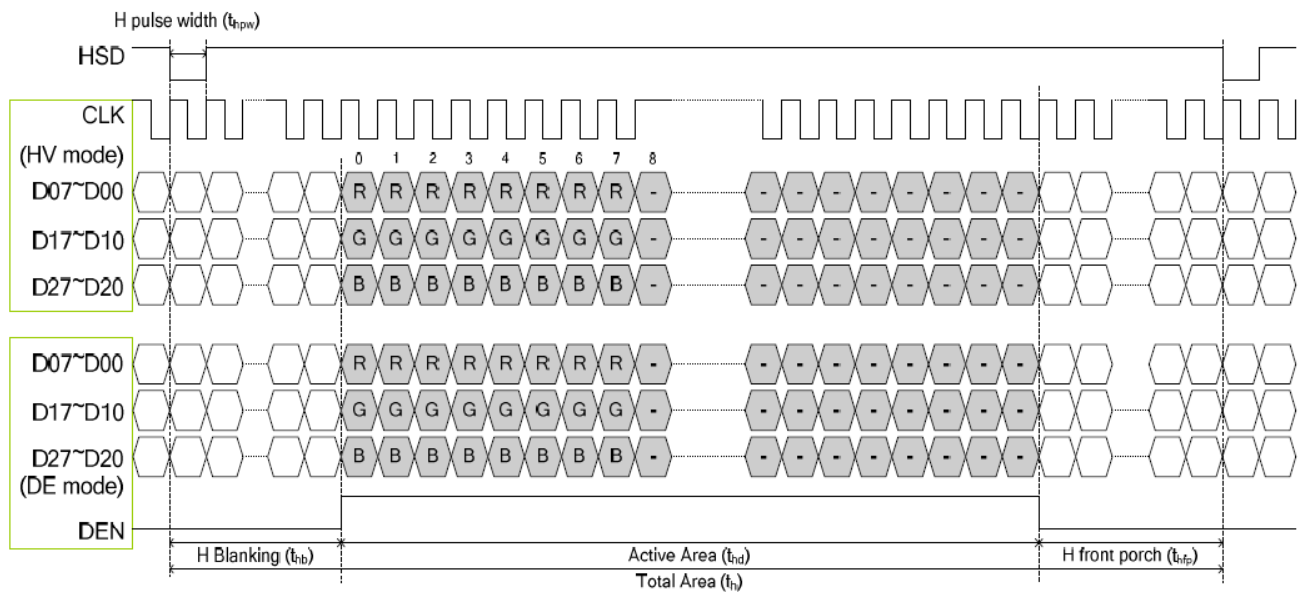

3.3.2.2 Vertical Timing

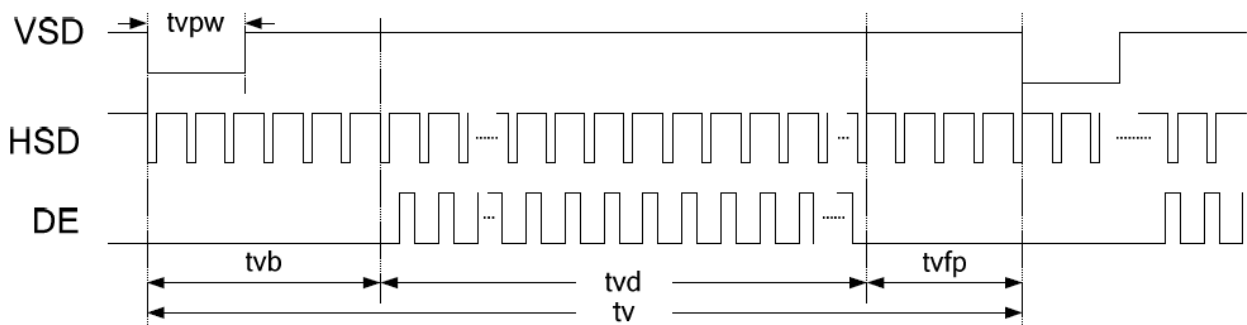

3.3.3 Clock and Data input waveforms

| Parameter | Symbol | Min. | Typ. | Max. | Unit. | Remark |
|------------------|--------|------|------|------|-------|--------|
| HS setup time | Thst | 8 | - | - | ns | |
| HS hold time | Thhd | 8 | - | - | ns | |
| VS setup time | Tvst | 8 | - | - | ns | |
| VS hold time | Tvhd | 8 | - | - | ns | |
| Data setup time | Tdsu | 8 | - | - | ns | |
| Data hold time | Tdhd | 8 | - | - | ns | |
| DE setup time | Tesu | 8 | - | - | ns | |
| DE hold time | Tehd | 8 | - | - | ns | |
| CLKIN cycle time | Tcph | 20 | | | ns | |

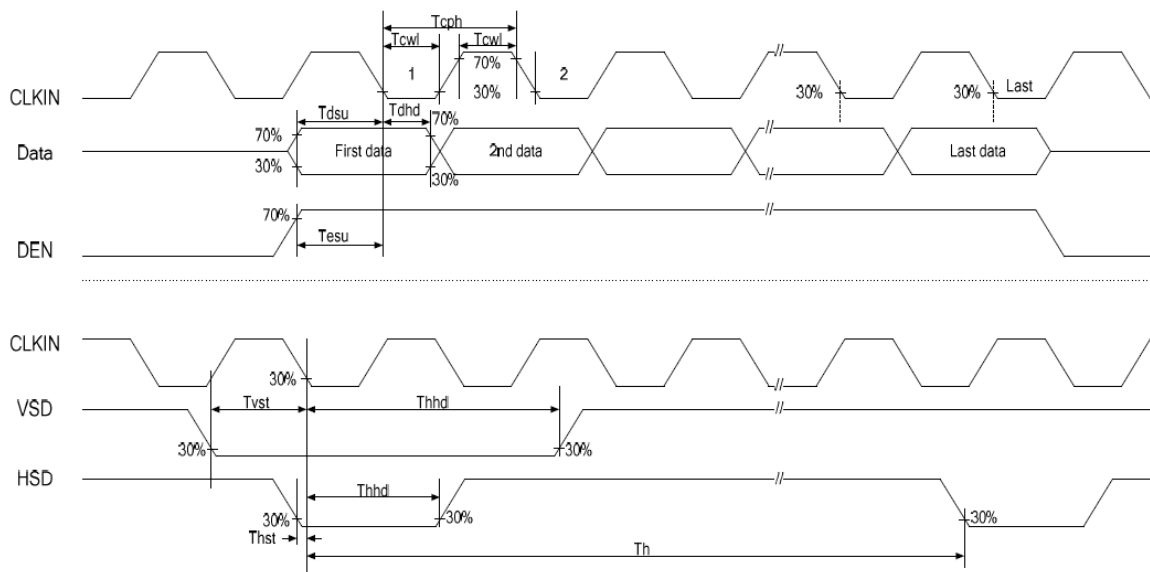

3.4 Backlight Unit

The Backlight system is an edge-lighting type with 30 white LED (Light Emitting Diode)

(Ta= 25±2°C)

| Characteristics | Symbol | Min. | Typ. | Max. | Unit | Note |
|-------------------|-----------------|---------|---------|--------|------|------|
| Forward Voltage | VB | (17) | (18) | (21.6) | V | |
| Forward Current | IB | - | 500 | 600 | mA | (1) |
| Power Consumption | P _{BL} | - | 9000 | 12960 | mW | (2) |
| LED Life time | - | (50000) | (60000) | - | hr | (3) |

Note (1) LEDs in 6 series x 5 parallel type.

(2) Where IB =500mA, VB = 18, P_{BL} = VB × IB

(3) The environmental conducted under ambient air flow ,at Ta=25±2°C, 60%RH±5%

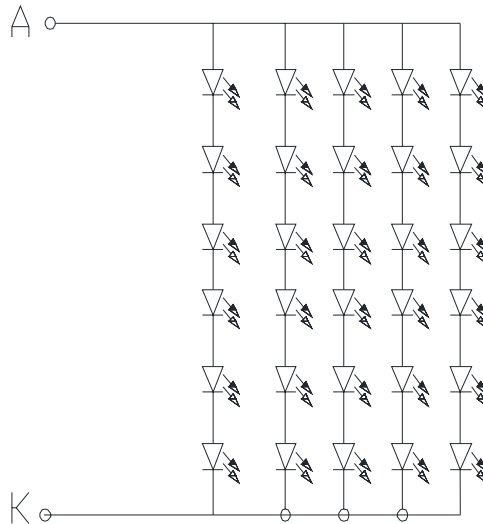

4. Optical Characteristics

4.1 Optical characteristic of the LCD

The following items are measured under stable conditions. The optical characteristics should be measured in a dark room or equivalent state with the methods.

Measuring equipment: BM-7A

| Item | Symbol | Condition | Min | Type | Max | Unit | Note | |
|-------------------------------|----------------|----------------------------|------------------------------|---------|---------|-------------------|--------|-------|
| Brightness | B | | (1000) | (1300) | -- | cd/m ² | | |
| Response time | T _r | θ=0° | - | 5 | 10 | ms | . | |
| | T _f | | -- | 15 | 20 | ms | | |
| Contrast ratio | CR | At optimized viewing angle | (300) | (500) | -- | -- | | |
| Luminance Uniformity | ΔL | | 70 | 75 | | % | | |
| Color Chromaticity (CIE 1931) | White | W _x | θ=0° Normal Viewing Angle | (0.270) | (0.320) | (0.370) | -- | BM-7A |
| | | W _y | | (0.300) | (0.350) | (0.400) | | |
| Viewing Angle (6H) | Hor. | θ _R | CR≥10 | 60 | 70 | -- | Degree | |
| | | θ _L | | 60 | 70 | -- | | |
| | Ver. | θ _U | | 40 | 50 | -- | | |
| | | θ _D | | 50 | 60 | -- | | |

a. Test equipment setup

After stabilizing and leaving the panel alone shall be warmed up for the stable operation of LCM, the measurement should be executed. Measurement should be executed in a stable, windless, and dark room. Optical specifications are measured by Topcon BM-7(fast) with a viewing angle of 2° at a distance of 50cm and normal direction.

b. Definition of response time: Tr and Tf

The response time is defined as the following figure and shall be measured by switching the input signal for "black" and "white".

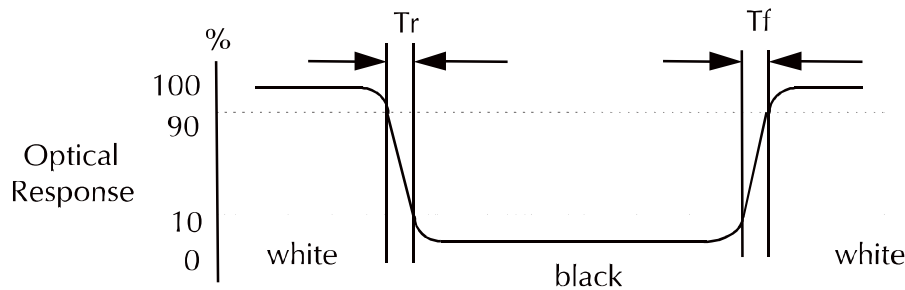

c. Definition of contrast ratio:

$$\text{Contrast Ratio (CR)} = \frac{\text{Brightness measured when LCD is at "white state"}}{\text{Brightness measured when LCD is at "black state"}}$$

- d. Measured at the center area of the panel when all the input terminals of LCD panel are electrically opened.
- e. View Angle

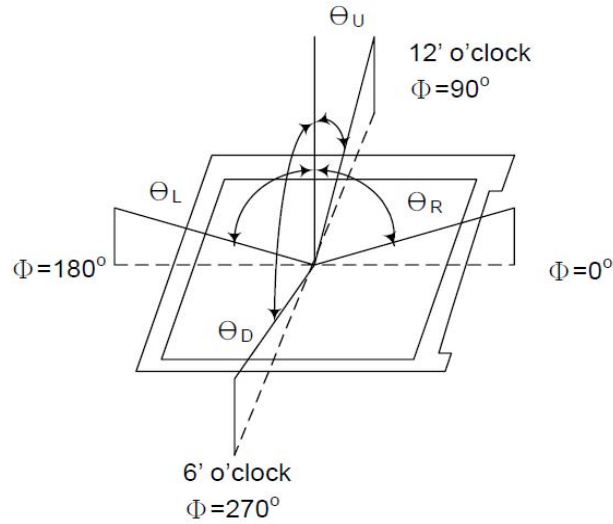

- f. Definition of Luminance of White: Luminance of white at the center points

| | |
|---------------------------------|----------|
| Light Source of Back-Light Unit | LED Type |
|---------------------------------|----------|

- g. Definition of White Uniformity

$$\text{White Uniformity} = \frac{\text{Min. luminance of white among 9-points}}{\text{Max. luminance of white among 9-points}} \times 100\%$$

- h. The definition of Color Gamut -Color Chromaticity CIE 1931

Color coordinate of white & red, green, blue at center point.

Color Gamut : NTSC(%) = (RGB Triangle Area / NTSC Triangle Area) x 100

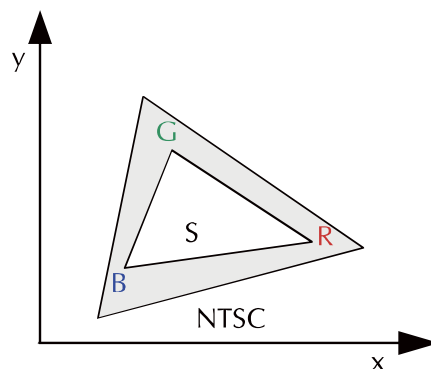

5. I/O Terminal

5.1 Pin Assignment (connector Part No: UJU MT-FP160N-2FR or equivalent.)

| Pin No. | Symbol | I/O | Function | Remark |
|---------|--------|-----|-----------------------------------|--------|
| 1 | GND | P | Ground | |
| 2 | AVDD | P | Analog input voltage | |
| 3 | VCC | P | Digital input voltage | |
| 4 | R0 | I | Red data signal (LSB) | |
| 5 | R1 | I | Red data signal | |
| 6 | R2 | I | Red data signal | |
| 7 | R3 | I | Red data signal | |
| 8 | R4 | I | Red data signal | |
| 9 | R5 | I | Red data signal | |
| 10 | R6 | I | Red data signal | |
| 11 | R7 | I | Red data signal (MSB) | |
| 12 | G0 | I | Green data signal (LSB) | |
| 13 | G1 | I | Green data signal | |
| 14 | G2 | I | Green data signal | |
| 15 | G3 | I | Green data signal | |
| 16 | G4 | I | Green data signal | |
| 17 | G5 | I | Green data signal | |
| 18 | G6 | I | Green data signal | |
| 19 | G7 | I | Green data signal (MSB) | |
| 20 | B0 | I | Blue data signal (LSB) | |
| 21 | B1 | I | Blue data signal | |
| 22 | B2 | I | Blue data signal | |
| 23 | B3 | I | Blue data signal | |
| 24 | B4 | I | Blue data signal | |
| 25 | B5 | I | Blue data signal | |
| 26 | B6 | I | Blue data signal | |
| 27 | B7 | I | Blue data signal (MSB) | |
| 28 | CLKIN | I | Dot clock input | |
| 29 | DEN | I | Data enable signal | |
| 30 | HSD | I | HSYNC signal | |
| 31 | VSD | I | VSYNC signal | |
| 32 | MODE | I | H: DE mode (Default) L: SYNC mode | |
| 33 | NC | - | No Connect (please leave it open) | |
| 34 | NC | - | No Connect (please leave it open) | |
| 35 | NC | - | NO Connect (please leave it open) | |
| 36 | VCC | P | Digital input voltage | |
| 37 | NC | - | NO Connect (please leave it open) | |
| 38 | GND | P | Ground | |
| 39 | GND | P | Ground | |
| 40 | AVDD | P | Analog input voltage | |
| 41 | VCOM | P | VCOM DC input | |

| | | | | |
|----|----------|---|--|--|
| 42 | DITH | I | Dithering function setting H: Disable dithering function L: Enable dithering function | |
| 43 | NC | - | NO Connect (please leave it open) | |
| 44 | VCOM out | O | connect a capacitor | |
| 45 | NC | - | NO Connect (please leave it open) | |
| 46 | NC | - | NO Connect (please leave it open) | |
| 47 | NC | - | NO Connect (please leave it open) | |
| 48 | NC | - | NO Connect (please leave it open) | |
| 49 | NC | - | NO Connect (please leave it open) | |
| 50 | NC | - | NO Connect (please leave it open) | |
| 51 | NC | - | NO Connect (please leave it open) | |
| 52 | NC | - | NO Connect (please leave it open) | |
| 53 | NC | - | NO Connect (please leave it open) | |
| 54 | NC | - | NO Connect (please leave it open) | |
| 55 | NC | - | NO Connect (please leave it open) | |
| 56 | VGH | P | TFT turn on voltage | |
| 57 | VCC | P | Digital input voltage | |
| 58 | VGL | P | TFT turn off voltage | |
| 59 | GND | P | Ground | |
| 60 | NC | - | NO Connect (please leave it open) | |

I: Input, P: Power

Notes (1): VSS Pin must ground contact, can not be floating.

5.2 Backlight Unit (Connector Part No: JST:BHSR-02VS-01(N) or equivalent.)

| Pin No. | Symbol | Function | Remark |
|---------|--------|--------------------------------|--------|
| 1 | LEDA | Power Supply for LED backlight | Red |
| 2 | LEDK | GND for LED backlight | White |

5.3 Block Diagram

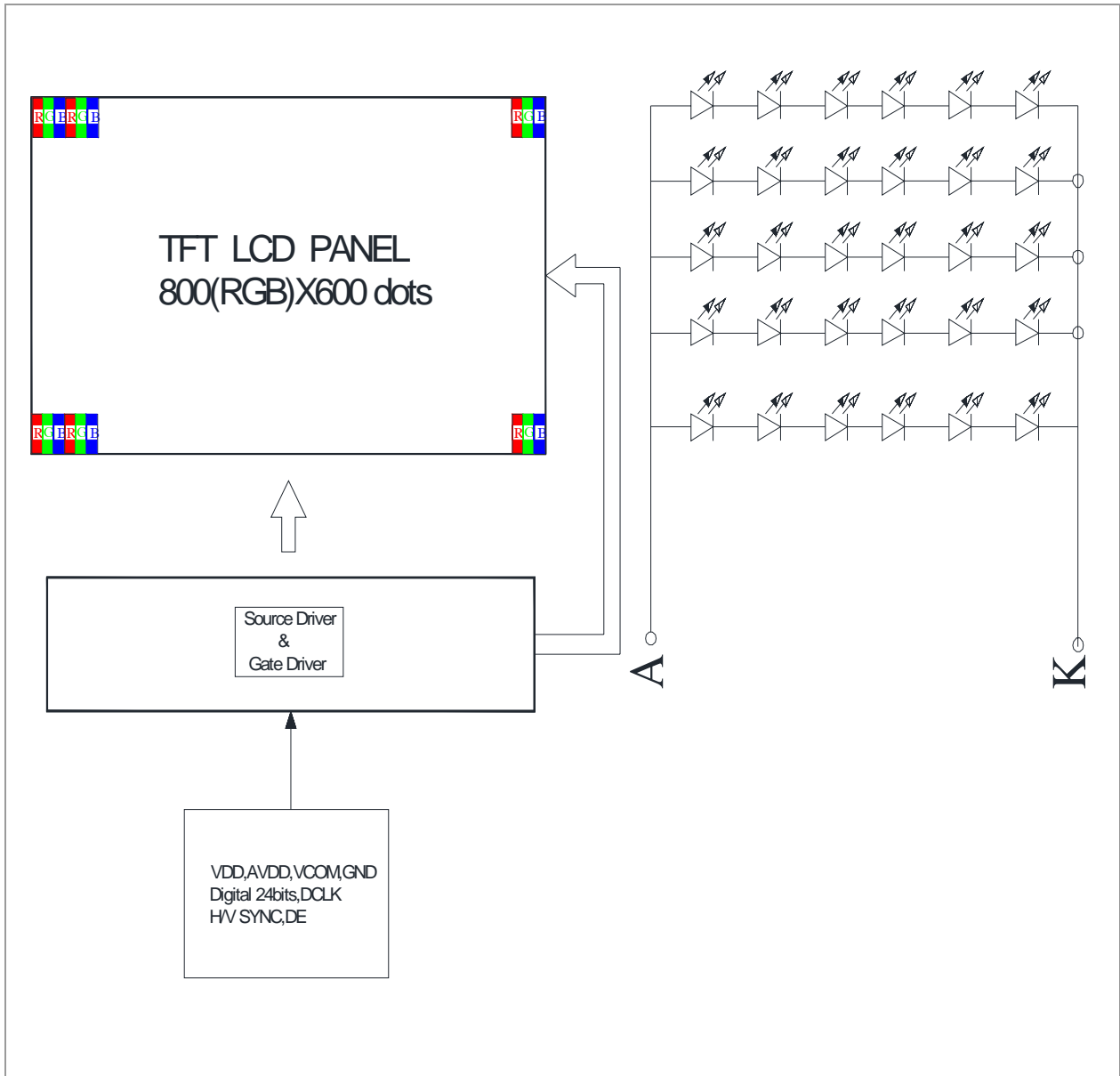

6. Displayed Color and Input Data

| | Color & Gray Scale | Data Signal | | | | | | | | | | | | | | | | | | | | | | | |
|-------------|--------------------|-------------|----|----|----|----|----|----|----|----|----|----|----|----|----|----|----|----|----|----|----|----|----|----|----|
| | | R7 | R6 | R5 | R4 | R3 | R2 | R1 | R0 | G7 | G6 | G5 | G4 | G3 | G2 | G1 | G0 | B7 | B6 | B5 | B4 | B3 | B2 | B1 | B0 |
| Basic Color | Black | 0 | 0 | 0 | 0 | 0 | 0 | 0 | 0 | 0 | 0 | 0 | 0 | 0 | 0 | 0 | 0 | 0 | 0 | 0 | 0 | 0 | 0 | 0 | |
| | Red(0) | 1 | 1 | 1 | 1 | 1 | 1 | 1 | 1 | 0 | 0 | 0 | 0 | 0 | 0 | 0 | 0 | 0 | 0 | 0 | 0 | 0 | 0 | 0 | |
| | Green(0) | 0 | 0 | 0 | 0 | 0 | 0 | 0 | 0 | 1 | 1 | 1 | 1 | 1 | 1 | 1 | 1 | 0 | 0 | 0 | 0 | 0 | 0 | 0 | |
| | Blue(0) | 0 | 0 | 0 | 0 | 0 | 0 | 0 | 0 | 0 | 0 | 0 | 0 | 0 | 0 | 0 | 0 | 1 | 1 | 1 | 1 | 1 | 1 | 1 | |
| | Cyan | 0 | 0 | 0 | 0 | 0 | 0 | 0 | 0 | 1 | 1 | 1 | 1 | 1 | 1 | 1 | 1 | 1 | 1 | 1 | 1 | 1 | 1 | 1 | |
| | Magenta | 1 | 1 | 1 | 1 | 1 | 1 | 1 | 1 | 0 | 0 | 0 | 0 | 0 | 0 | 0 | 0 | 1 | 1 | 1 | 1 | 1 | 1 | 1 | |
| | Yellow | 1 | 1 | 1 | 1 | 1 | 1 | 1 | 1 | 1 | 1 | 1 | 1 | 1 | 1 | 1 | 1 | 0 | 0 | 0 | 0 | 0 | 0 | 0 | |
| | White | 1 | 1 | 1 | 1 | 1 | 1 | 1 | 1 | 1 | 1 | 1 | 1 | 1 | 1 | 1 | 1 | 1 | 1 | 1 | 1 | 1 | 1 | 1 | |
| Red | Black | 0 | 0 | 0 | 0 | 0 | 0 | 0 | 0 | 0 | 0 | 0 | 0 | 0 | 0 | 0 | 0 | 0 | 0 | 0 | 0 | 0 | 0 | | |
| | Red(1) | 0 | 0 | 0 | 0 | 0 | 0 | 0 | 1 | 0 | 0 | 0 | 0 | 0 | 0 | 0 | 0 | 0 | 0 | 0 | 0 | 0 | 0 | | |
| | Red(2) | 0 | 0 | 0 | 0 | 0 | 0 | 1 | 0 | 0 | 0 | 0 | 0 | 0 | 0 | 0 | 0 | 0 | 0 | 0 | 0 | 0 | 0 | | |
| | : | : | : | : | : | : | : | : | : | : | : | : | : | : | : | : | : | : | : | : | : | : | : | | |
| | Red(127) | 0 | 1 | 1 | 1 | 1 | 1 | 1 | 1 | 0 | 0 | 0 | 0 | 0 | 0 | 0 | 0 | 0 | 0 | 0 | 0 | 0 | 0 | | |
| | : | : | : | : | : | : | : | : | : | : | : | : | : | : | : | : | : | : | : | : | : | : | : | | |
| | Red(254) | 1 | 1 | 1 | 1 | 1 | 1 | 1 | 0 | 0 | 0 | 0 | 0 | 0 | 0 | 0 | 0 | 0 | 0 | 0 | 0 | 0 | 0 | | |
| | Red(255) | 1 | 1 | 1 | 1 | 1 | 1 | 1 | 1 | 0 | 0 | 0 | 0 | 0 | 0 | 0 | 0 | 0 | 0 | 0 | 0 | 0 | 0 | | |
| Green | Black | 0 | 0 | 0 | 0 | 0 | 0 | 0 | 0 | 0 | 0 | 0 | 0 | 0 | 0 | 0 | 0 | 0 | 0 | 0 | 0 | 0 | 0 | | |
| | Green(1) | 0 | 0 | 0 | 0 | 0 | 0 | 0 | 0 | 0 | 0 | 0 | 0 | 0 | 0 | 1 | 0 | 0 | 0 | 0 | 0 | 0 | 0 | | |
| | Green(2) | 0 | 0 | 0 | 0 | 0 | 0 | 0 | 0 | 0 | 0 | 0 | 0 | 0 | 1 | 0 | 0 | 0 | 0 | 0 | 0 | 0 | 0 | | |
| | : | : | : | : | : | : | : | : | : | : | : | : | : | : | : | : | : | : | : | : | : | : | : | | |
| | Green(127) | 0 | 0 | 0 | 0 | 0 | 0 | 0 | 0 | 0 | 1 | 1 | 1 | 1 | 1 | 1 | 1 | 0 | 0 | 0 | 0 | 0 | 0 | | |
| | : | : | : | : | : | : | : | : | : | : | : | : | : | : | : | : | : | : | : | : | : | : | : | | |
| | Green(254) | 0 | 0 | 0 | 0 | 0 | 0 | 0 | 0 | 1 | 1 | 1 | 1 | 1 | 1 | 1 | 0 | 0 | 0 | 0 | 0 | 0 | 0 | | |
| | Green(255) | 0 | 0 | 0 | 0 | 0 | 0 | 0 | 0 | 1 | 1 | 1 | 1 | 1 | 1 | 1 | 1 | 0 | 0 | 0 | 0 | 0 | 0 | | |
| Blue | Black | 0 | 0 | 0 | 0 | 0 | 0 | 0 | 0 | 0 | 0 | 0 | 0 | 0 | 0 | 0 | 0 | 0 | 0 | 0 | 0 | 0 | 0 | | |
| | Blue(1) | 0 | 0 | 0 | 0 | 0 | 0 | 0 | 0 | 0 | 0 | 0 | 0 | 0 | 0 | 0 | 0 | 0 | 0 | 0 | 0 | 0 | 1 | | |
| | Blue(2) | 0 | 0 | 0 | 0 | 0 | 0 | 0 | 0 | 0 | 0 | 0 | 0 | 0 | 0 | 0 | 0 | 0 | 0 | 0 | 0 | 0 | 1 | | |
| | : | : | : | : | : | : | : | : | : | : | : | : | : | : | : | : | : | : | : | : | : | : | : | | |
| | Blue(127) | 0 | 0 | 0 | 0 | 0 | 0 | 0 | 0 | 0 | 0 | 0 | 0 | 0 | 0 | 0 | 0 | 1 | 1 | 1 | 1 | 1 | 1 | | |
| | : | : | : | : | : | : | : | : | : | : | : | : | : | : | : | : | : | : | : | : | : | : | : | | |
| | Blue(254) | 0 | 0 | 0 | 0 | 0 | 0 | 0 | 0 | 0 | 0 | 0 | 0 | 0 | 0 | 0 | 1 | 1 | 1 | 1 | 1 | 1 | 0 | | |
| | Blue(255) | 0 | 0 | 0 | 0 | 0 | 0 | 0 | 0 | 0 | 0 | 0 | 0 | 0 | 0 | 0 | 1 | 1 | 1 | 1 | 1 | 1 | 1 | | |

0 : Low level voltage, 1 :High level voltage

Each basic color can be displayed in 256 gray scales from 8 bit data signals. With the combination of total 24 bit data signals, the 16.2M-color display can be achieved on the screen.

7. Reliability Condition

No change on display and in operation under the following test condition.

Condition: Unless otherwise specified, tests will be conducted under the following condition.

Temperature: 20±5°C.

Humidity: 65±5%RH.

Tests will be not conducted under functioning state.

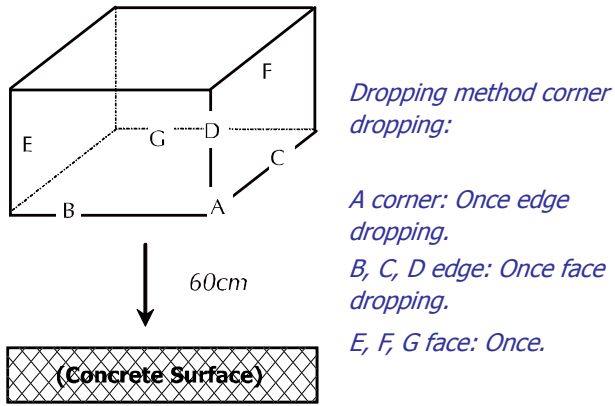
| No. | Parameter | Condition | Notes |
|-----|---|---|-------|
| 1 | High Temperature Operating | 70°C±2°C, 240hrs (Operation state). | |
| 2 | Low Temperature Operating | -20°C±2°C, 240hrs (Operation state). | 1 |
| 3 | High Temperature Storage | 80°C±2°C, 240hrs. | 2 |
| 4 | Low Temperature Storage | -30°C±2°C, 240hrs. | 1,2 |
| 5 | High Temperature and High Humidity Operation Test | 60°C±2°C, 90%, 240hrs. | 1,2 |
| 6 | Vibration Test | Total fixed amplitude: 1.5mm. Vibration Frequency: 10~55Hz. One cycle 60 seconds to 3 direction of X, Y, Z each 15 minutes. | 3 |
| 7. | Drop Test | To be measured after dropping from 60cm high on the concrete surface in packing state.  <i>Dropping method corner dropping:</i> <i>A corner: Once edge dropping.</i> <i>B, C, D edge: Once face dropping.</i> <i>E, F, G face: Once.</i> | |

- Notes:
1. No dew condensation to be observed.
 2. The function test shall be conducted after 4 hours storage at the normal temperature and humidity after removed from the test chamber.
 3. Vibration test will be conducted to the product itself without putting I in a container.

8. Dimensional Outlines

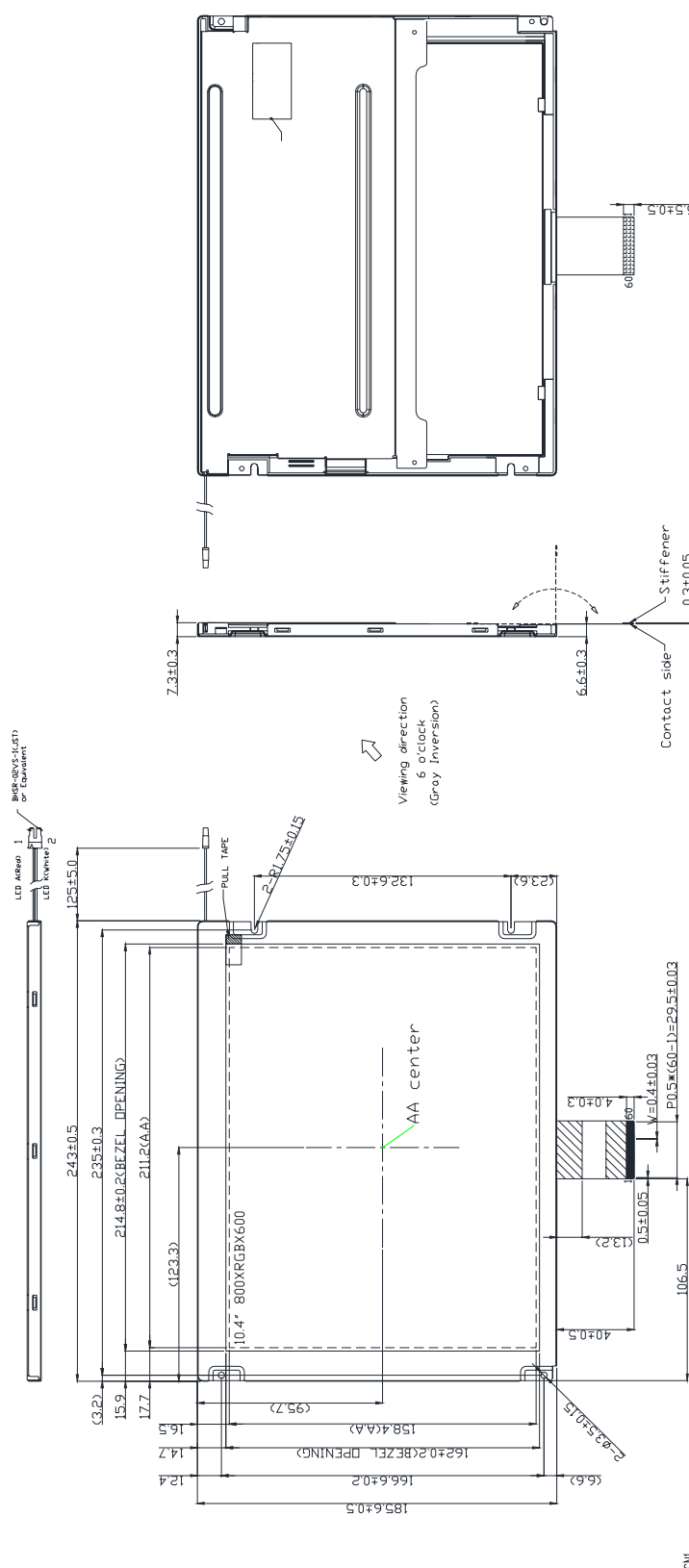

Pin

| | | | |
|----|------|----|---------------------|
| 1 | 21 | 41 | VCOM |
| 2 | AVDD | 42 | DITH |
| 3 | VCC | 43 | NC |
| 4 | R0 | 44 | VCOM _{int} |
| 5 | R1 | 45 | NC |
| 6 | R2 | 46 | NC |
| 7 | R3 | 47 | NC |
| 8 | R4 | 48 | NC |
| 9 | R5 | 49 | NC |
| 10 | R6 | 50 | NC |
| 11 | R7 | 51 | NC |
| 12 | G0 | 52 | NC |
| 13 | G1 | 53 | NC |
| 14 | G2 | 54 | NC |
| 15 | G3 | 55 | NC |
| 16 | G4 | 56 | VGH |
| 17 | G5 | 57 | VCC |
| 18 | G6 | 58 | VGL |
| 19 | G7 | 59 | GND |
| 20 | AVDD | 60 | NC |

Connector:UJU MT-FP160N-2FR or Equivalent

9. Incoming Inspection Standards

9.1 Inspection and Environment Conditions

9.1.1 Inspection Conditions:

- (1) Inspection Distance: 35 cm±5cm
- (2) View Angle : Light-on Inspection Angle : ±5°
Cosmetic Inspection Angle : ±45°

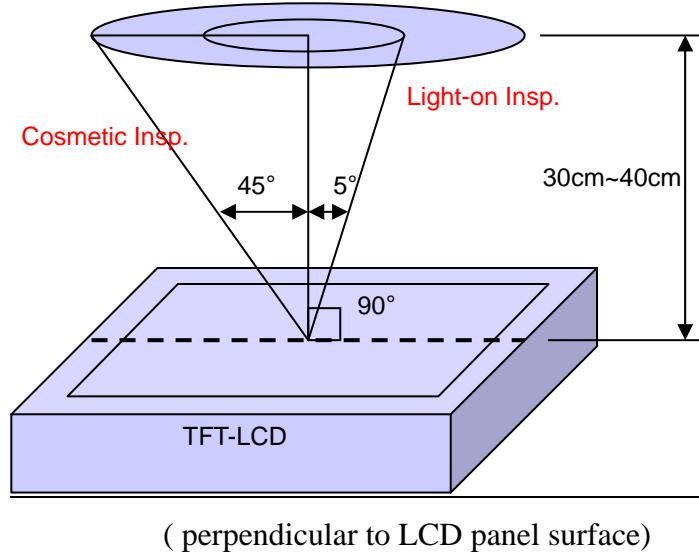

9.1.2 Environment Conditions:

| | | |
|----------------------|-----------------------|-------------------|
| Ambient Temperature | | 23°C±5°C |
| Ambient Humidity | | 55±10%RH |
| Ambient Illumination | Cosmetic Inspection | more than 600 Lux |
| | Functional Inspection | 300~500 Lux |

9.1.3 Sampling Conditions:

- (1) Lot Size: Quantity of shipment lot per model
- (2) Sampling Method:

| | | |
|---------------|--------------|------------------------------------|
| Sampling Plan | | MIL-STD-105E |
| | | Normal Inspection, Single Sampling |
| | | Level II |
| AQL | Major Defect | 1.0% |
| | Minor Defect | 1.5% |

- (3) The classification of Major(MA) and Minor(MI) defects is shown as 3. Inspection Criteria.

9.1.4 Inspection Criteria

9.1.4.1 Cosmetic Inspection(Panel):

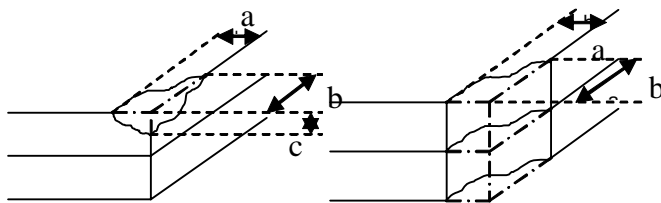
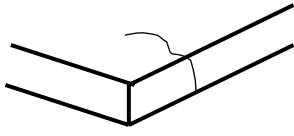
| Item | Judgment Criteria | Classification |
|---------------------------------------|---|----------------|
| Chipping on Panel |  <p>$a \leq 3.0\text{mm}$, $b \leq 3.0\text{mm}$, $c \leq t$ (Bottom glass thickness)</p> | MA |
| Scratch on Panel *Note-2 | <p>$W \leq 0.05\text{mm}$ or $L < 5\text{mm}$: Ignored $0.05\text{mm} < W \leq 0.1\text{mm}$ and $L \leq 5\text{mm}$: $N \leq 5$ $W > 0.1\text{mm}$ or $L > 5\text{mm}$: Not allowed</p> | MI |
| Bubble or Dent on Panel *Note-3 | <p>$D \leq 0.2\text{mm}$: Ignored $0.2\text{mm} < D \leq 0.3\text{mm}$: $N \leq 5$ $D > 0.3\text{mm}$: Not allowed</p> | MI |
| Panel Crack |  <p>Not Allowed crack</p> | MA |
| Bezel Deformation | Obvious deformation is not allowed. | MI |
| Bezel Oxidation | Not allowed if it rusts continuously over 1 cm (It is out of warranty with rusted tin plate) | MI |
| Bezel Scratch | L 20mm , W 0.2 , N 3 | MI |
| Metal Squash Dent /Flange(Front Side) | D(W) 1,L 3,N 3; | MI |
| B/L High Voltage Wire Denudation | Not allowed | MA |
| Polarizer flaw or leak out resin | Defect is defined as the active area. | MI |
| Outline Dimension | Must in Spec, refer to related product spec. | MI |

9.1.4.2 Functional Inspection:

| Item | Judgment Criteria | | | Classification |
|--|--|--|-------|----------------|
| | Area(Note1) | I | O | |
| Point Defect | Bright dot | Random | 2 | |
| | | 2 dots adjacent | 0 | 0 |
| | | 3 dots adjacent or more | 0 | 0 |
| | Dark dot | Random | 3 | |
| | | 2 dots adjacent | 1 | |
| | | 3 dots adjacent or more | 0 | 0 |
| | Total Dot Defect | | 5 | |
| | Distance | Distance between Bright and Bright dot | L 5mm | |
| | | Distance between Bright and Dark dot | L 5mm | |
| | | Distance between Dark dot | L 5mm | |
| (1) It is defined as Point Defect if defect area > 0.5dot (2) It is ignored if defect area ≤ 0.5dot (3) Weak point defect will be defined as Bright Dot if it can be observed through ND filter 5% (Full Screen Black Inspection) | | | | MI |
| Line Defect | Obvious vertical or horizontal line defect is not allowed. | | | |
| Mura | Not allowed if it can be observed through ND Filter 5 % | | | |
| Foreign Material in spot shape *Note-3 | D ≤ 0.2mm: Ignored | | | |
| | 0.2mm < D ≤ 0.5mm: N ≤ 8 | | | |
| | D > 0.5mm: Not allowed | | | |
| Foreign Material in line or spiral shape *Note-4 | W ≤ 0.05mm or L ≤ 5mm: Ignored | | | |
| | 0.05mm < W ≤ 0.2mm and L 1.0mm ≤ 5mm: N ≤ 8 | | | |
| | W > 0.2mm or L > 5mm: Not allowed | | | |
| Display Function Abnormal | No Malfunction can be allowed | | | |

Note-1 : I/O Area Definition

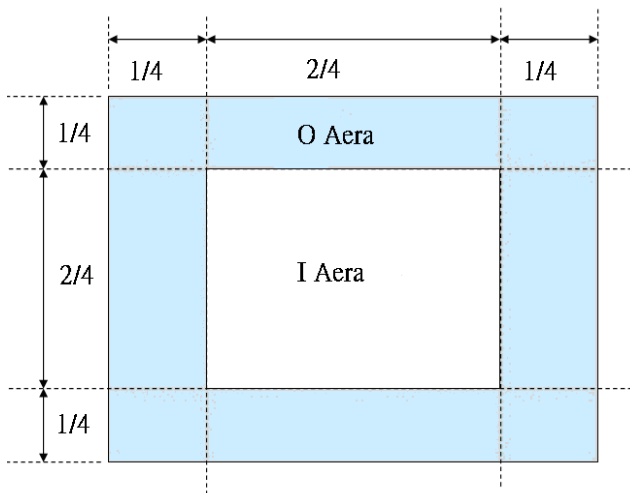

Note-2 : Polarizer Scratch

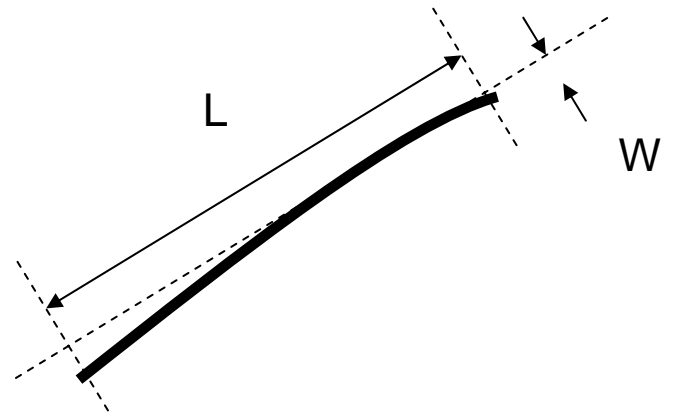

Note-3 : Spot Foreign Material

$(W \geq L / 4)$

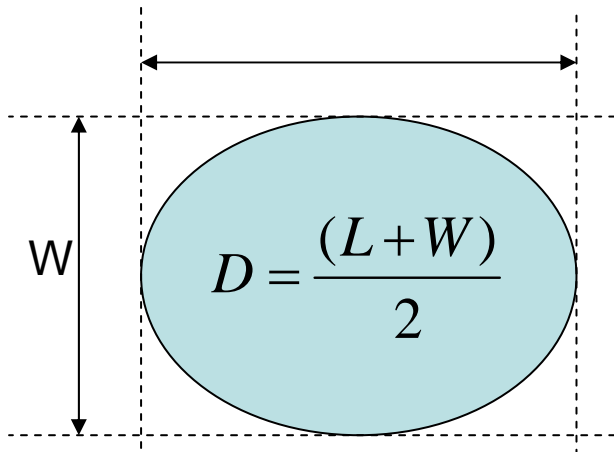

Note-4 : Line or Spiral Foreign Material

$(W < L / 4)$

