

Display Elektronik GmbH

DATA SHEET

LCD MODULE

**DEM 640480C TMH-PW-N
(A-TOUCH)**

5,7" TFT with Touch-Panel

Product Specification

Ver.: 2

05/11/2010

Revise Records

Rev.	Date	Contents	Written	Approved
0	28.04.2010	Preliminary Specification	KC	MH
1	01.06.2010	Correction Clock and Data Waveform	KC	MH
2	05.11.2010	Add ROHS Compliance Description	KC	MH

Special Notes

Note1.	
Note2.	
Note3.	
Note4.	
Note5.	

Contents

1. General Description and Features	4
1.1 Features	4
1.2 LCD Module	4
2. Mechanical Information	4
3. Electrical Specifications	5
3.1 Absolute Max. Ratings	5
3.2 Electrical Characteristics	7
3.3 AC Timing Characteristic of The LCD	8
3.4 Back-Light Unit	10
4. Optical Characteristics	10
4.1 Optical characteristic of the LCD.....	10
5. I/O Terminal	13
5.1 Pin Assignment	13
5.2 Block Diagram.....	14
5.3 Back-light Unit (BLU)	14
5.4 Basic Display Color and Gray Scale	15
6. Touch Screen Panel	16
6.1 Electrical Characteristics.....	16
6.2 Mechanical & Reliability Characteristics	16
7. Reliability Condition	17
8. Dimensional Outlines	18

1. General Description and Features

DEM 640480C TMH-PW-N (A-TOUCH) is a transmissive type color active matrix TFT (Thin Film Transistor) liquid crystal display (LCD) that uses amorphous silicon TFT as a switching device. This model is composed of a TFT-LCD module, a driver circuit and a back-light unit and touch screen panel (TSP). Graphics and texts can be displayed on a VGA 640 (W) x 3 x 480 (H) dots with 262,144 colors by supplying 18 bits data signal (6bits/each color). The following table described the features of DEM 640480C TMH-PW-N (A-TOUCH).

1.1 Features

- Transmissive and back-light with 21th LEDs are available.
- TN (Twisted Nematic) mode.
- Digital RGB (6bits/color) data transfer.
- Clock signal: latching data at the falling edge.
- ROHS Compliance.

1.2 LCD Module

Item	Specification	Unit
Screen Size	5.7 inches	Diagonal
Display Resolution	640 (H) x 480 (V)	Pixel
Active Area	115.20 (H) x 86.40 (V)	mm
Display Mode	Normally white mode/ Transmissive/ Wide view	--
Pixel Arrangement	R,G,B Vertical Tripe	--
Pixel size	181.5 x 181.5	um
Display Color	262K Colors	--
Viewing Direction	6 o'clock	--
Input Interface	Digital RGB (6bits/color) Data Transfer	--

2. Mechanical Information

Item		Min.	Typ.	Max.	Unit	Note
Module Size	Horizontal (H)	--	144.00	--	mm	(1,2,3)
	Vertical (V)	--	104.60	--	mm	(2)
	Thickness (T)	--	14.5	--	mm	(1,3)
Weight		--	TBD	--	g	--

Note (1) Not include FPC. Refer to the Outline Dimension Drawing as attached.

(2) Back-light unit is included.

(3) Excluding backlight cables.

3. Electrical Specifications

3.1 Absolute Max. Ratings

3.1.1 Absolute Ratings of Environment

If the operating condition exceeds the following absolute maximum ratings, the TFT LCD module may be damaged permanently.

(Ta=25±2°C, Vss=GND=0)

Item	Symbol	Min.	Max.	Unit	Note
Storage temperature	T _{STG}	-30	80	°C	(1)
Operating temperature	T _{OPR}	-20	70	°C	(1,2,3)

Note (1) 95 % RH Max. (40 °C ≥ Ta). Maximum wet-bulb temperature at 39 °C or less. (Ta > 40 °C) No condensation.

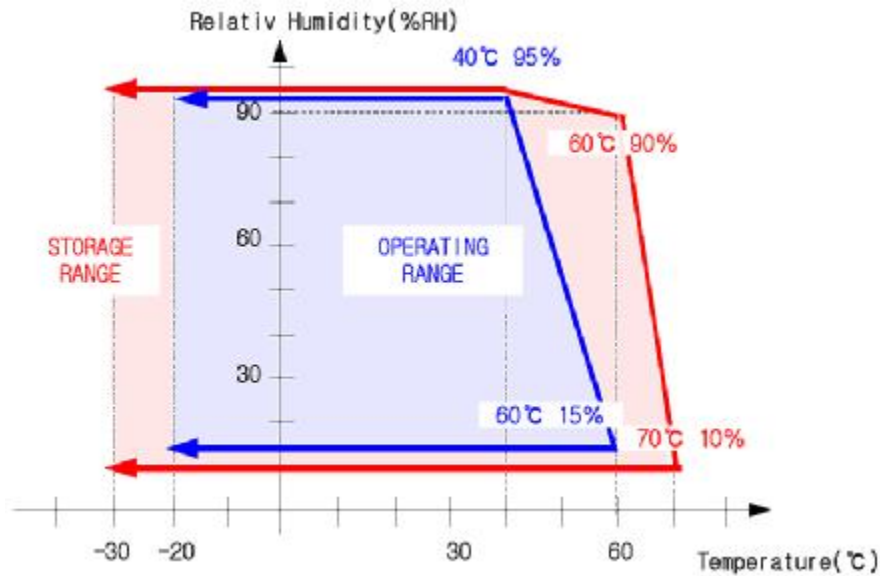

Note (2) In case of below 0°, the response time of liquid crystal (LC) becomes slower and the color of panel becomes darker than normal one. Level of retardation depends on temperature, because of LC's character

Note (3) Only operation is guaranteed at operating temperature. Contrast, response time, another display quality are evaluated at +25°C.

3.1.2 Electrical Absolute Maximum Ratings

(V_{SS}=GND=0)

Parameter	Symbol	Min.	Max.	Unit	Remark
Power supply voltage	V _{CC}	-0.3	5.0	V	
Signal input voltage	R0-R5,G0-G5, B0-B5,DCLK,DE	-0.3	V _{CC} +0.3	V	--
Permissive input ripple voltage	V _{RF}	--	100	mVp-p	V _{CC} = +3.3V

Display On/Off Sequence :

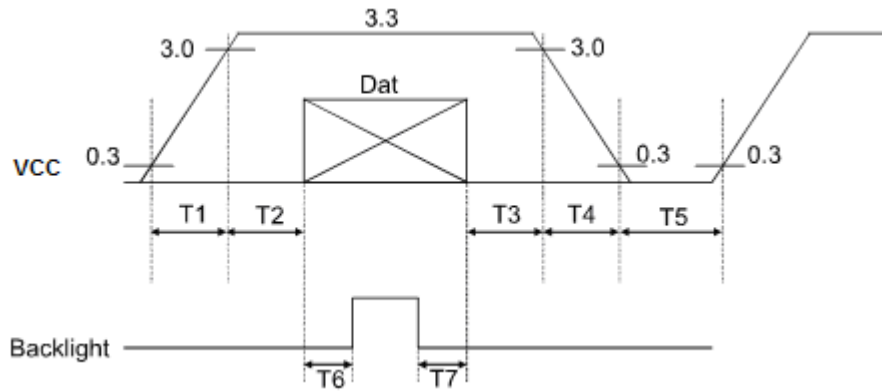

Data: DCLK, R0 ~ R5, G0 ~ G5, B0 ~ B5, DE

T1≤10ms, 50ms≤T2, 0<T3≤50ms, 0<T4≤10ms, 1s≤T5, 200ms≤T6, 200ms≤T7

3.2 Electrical Characteristics

3.2.1 DC Electrical Characteristics of the TFT LCD

(Ta=25±2°C, Vss=GND=0)

Item	Symbol	Min.	Typ.	Max.	Unit	Remark
Power supply	VCC	3.0	3.3	3.6	V	Note 1
Input Voltage for logic	H Level	0.7VDD	-	VDD	V	
	L Level	0	-	0.3VDD	V	
Power Supply current	ICC		(120)	TBD	mA	Note 2

Note1: Vcc-dip conditions

Vcc-dip conditions should also follow the Vcc-turn-on conditions

Td ≤ 10ms

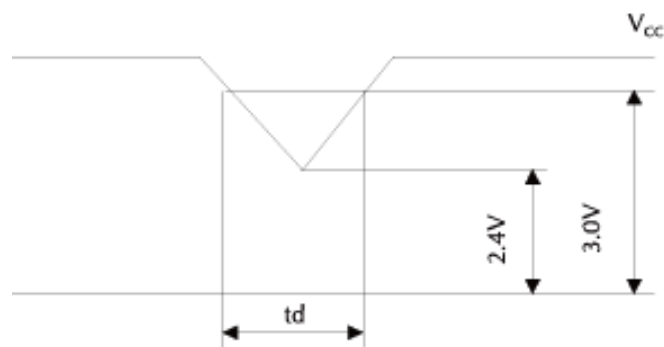

Note2: fv =60Hz , Ta=25°C , Display pattern : 64 Gray pattern

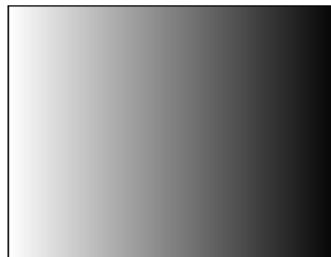

3.3 AC Timing Characteristic of The LCD

3.3.1 Timing Condition

Parameter	Symbol	Min.	Typ.	Max.	Unit.	Remark
CLK frequency	F _{CPH}	--	25.175	--	MHZ	
CLK period	T _{CPH}	--	39.7	--	ns	
CLK pulse duty	T _{CWH}	40	50	60	%	
HS period	T _H	--	800	--	T _{CPH}	
HS pulse width	T _{WH}	5	30	--	T _{CPH}	
HS-DEN time	T _{HS}	112	144	175	T _{CPH}	
DEN pulse width	T _{EP}	--	640	--	T _{CPH}	
VS pulse width	T _{WV}	1	3	5	T _H	
VS-DEN time	T _{STV}	--	35	--	T _H	
VS period	T _V	--	525	--	T _H	

Note : When SYNC mode is used, 1st data start from 144th CLK after HS falling (when STHD[5:0]=00000)

Parameter	Symbol	Min.	Typ.	Max.	Unit.	Remark
OEV pulse width	T _{CVE}	--	100	--	T _{CPH}	
CKV pulse width	T _{CKV}	--	96	--	T _{CPH}	
HS-CKV time	T ₁	--	52	--	T _{CPH}	
HS-OEV tim	T ₂	--	8	--	T _{CPH}	
HS-POL time	T ₃	--	72	--	T _{CPH}	
STV setup time	T _{SUV}	--	46	--	T _{CPH}	
STV pulse width	T _{WSTV}	--	1	--	T _H	

3.3.2 Clock and Data Waveform

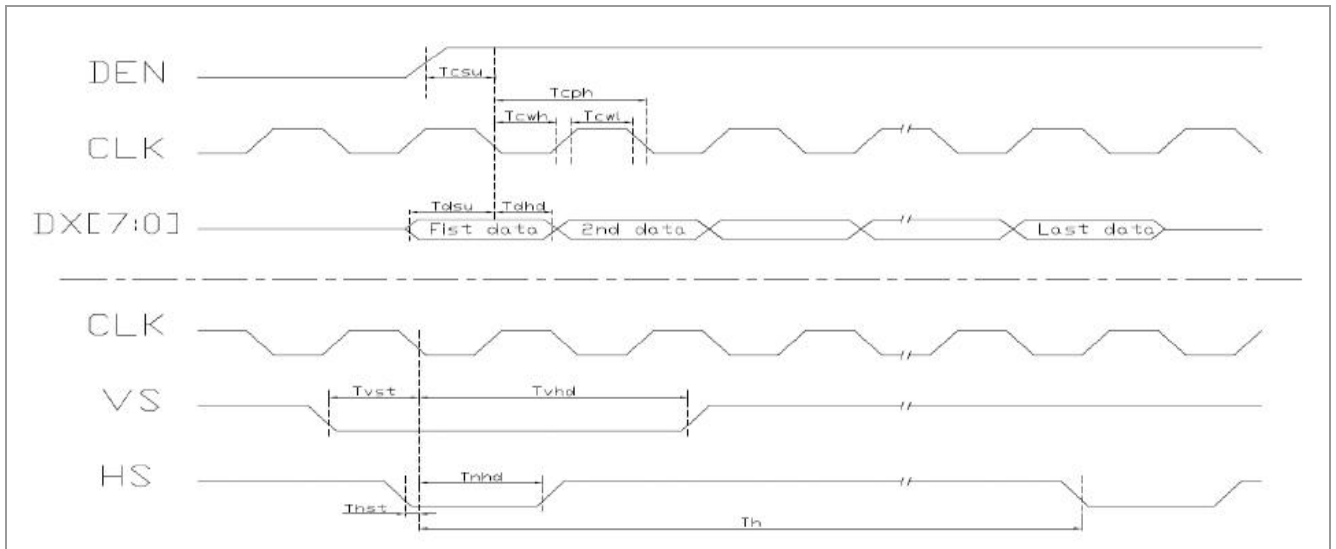

3.3.3 Data input format for parallel RGB Mode

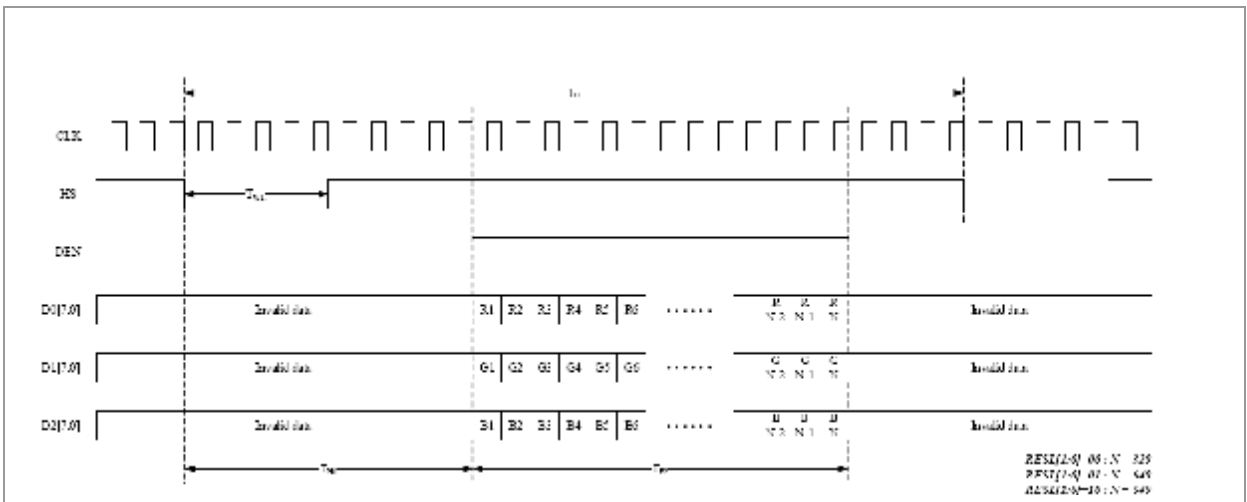

3.3.4 Digital RGB mode Horizontal timing for RESL[1:0]=10

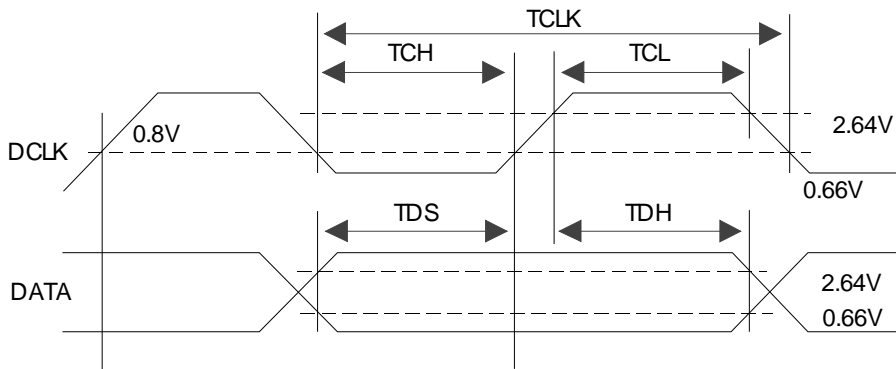
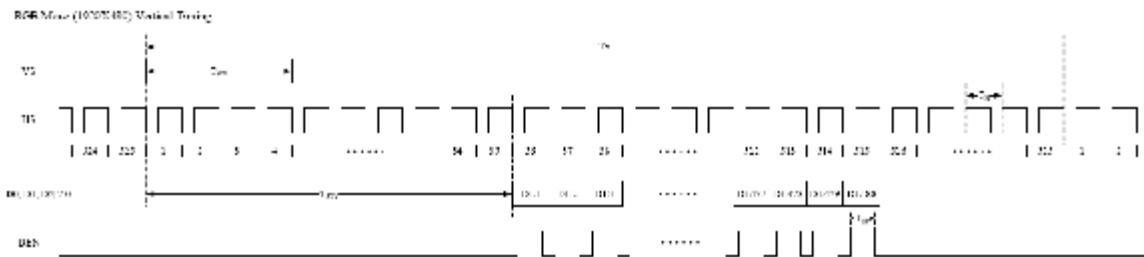

3.4 Back-Light Unit

The Back-light system is an edge-lighting type with 21 white LED (Light Emitting Diode)s. The characteristics of 21 white LEDs are shown in the following tables.

(Ta= Room Temp)

Characteristics		Symbol	Min.	Typ.	Max.	Unit	Note
Current of Back-light Unit		I_B	-	140	TBD	mA	(1)
Voltage of Back-light Unit		V_B	-	(9.9)	-	V	
Power Consumption		P_{BL}	-	(1386)	-	mW	(2)
LED Life Time	25°C	-	(40000)	-	-	hr	(3)

Note (1) LEDs in 3 series x 7 parallel type.

(2) Where $I_B = 140\text{mA}$, $V_B = 9.9$, $P_{BL} = V_B \times I_B$

(3) The environmental conducted under ambient air flow ,at $T_a=25\pm 2^\circ\text{C}$, $60\%\text{RH}\pm 5\%$

4. Optical Characteristics

4.1 Optical characteristic of the LCD

The following items are measured under stable conditions. The optical characteristics should be measured in a dark room or equivalent state with the methods shown in Note (1).

Measuring equipment: BM-5A, BM-7

Item		Symbol	Condition	Min	Type	Max	Unit	Note
Brightness				240	(290)	--	cd/m ²	
Response time		T_r	$\theta=0^\circ$	-	15	20	ms	
		T_f		--	25	35	ms	
Contrast ratio		CR	At optimized viewing angle	300	(450)	--	--	
Color Gamut		NTSC %	--	--	50	--	%	
Color Chromaticity (CIE 1931)		Red	R_x	$\theta=0^\circ$ Normal Viewing Angle	0.585	0.615	0.645	--
			R_y		0.314	0.344	0.374	
		Green	G_x		0.277	0.307	0.337	--
			G_y		0.532	0.562	0.592	
		Blue	B_x		0.103	0.133	0.163	--
			B_y		0.120	0.150	0.180	
		White	W_x		0.279	0.309	0.339	--
			W_y		0.320	0.350	0.380	
Viewing Angle (6H)		Hor.	θ_R	CR \geq 10	55	65	--	Degree
			θ_L		55	65	--	
		Ver.	ϕ_H		40	50	--	
			ϕ_L		55	65	--	

a. Test equipment setup

After stabilizing and leaving the panel alone shall be warmed up for the stable operation of LCM, the measurement should be executed. Measurement should be executed in a stable, windless, and dark room. Optical specifications are measured by Topcon BM-7(fast) with a viewing angle of 2° at a distance of 50cm and normal direction.

b. Definition of response time: Tr and Tf

The response time is defined as the following figure and shall be measured by switching the input signal for “black” and “white”.

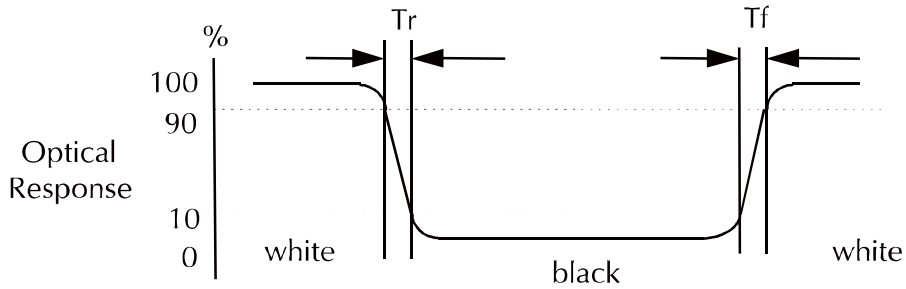

c. Definition of contrast ratio:

$$\text{Contrast Ratio (CR)} = \frac{\text{Brightness measured when LCD is at "white state"}}{\text{Brightness measured when LCD is at "black state"}}$$

d. Measured at the center area of the panel when all the input terminals of LCD panel are electrically opened.

e. View Angle

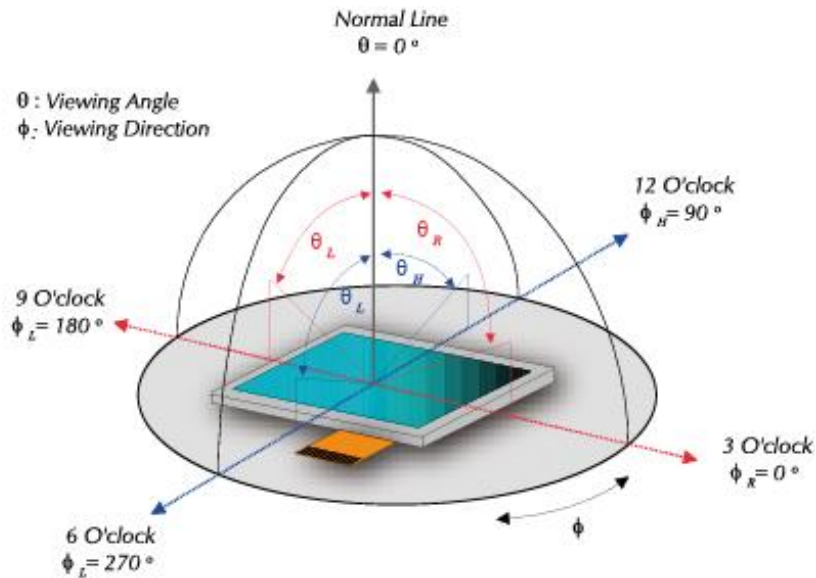

f. Definition of Luminance of White: Luminance of white at the center points

Light Source of Back-Light Unit	LED Type
---------------------------------	----------

g. Definition of White Uniformity

$$\text{White Uniformity} = \frac{\text{Min. luminance of white among 9-points}}{\text{Max. luminance of white among 9-points}}$$

h. The definition of Color Gamut -Color Chromaticity CIE 1931

Color coordinate of white & red, green, blue at center point.

Color Gamut : NTSC(%) = (RGB Triangle Area / NTSC Triangle Area) x 100

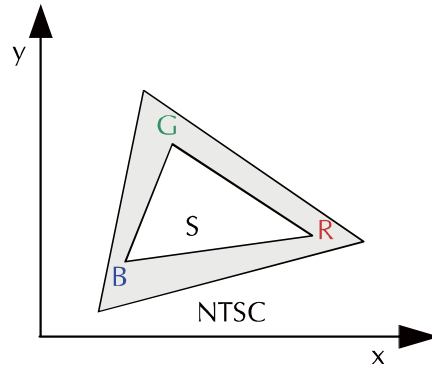

5. I/O Terminal

5.1 Pin Assignment

Pin No.	Symbol	I/O	Function	Remark
1	VSS	--	GND	
2	DCLK	I	Clock signal for sampling each data signal	
3	IHS	I	Horizontal synchronous signal (Negative)	
4	IVS	I	Vertical synchronous signal (Negative)	
5	VSS	I	GND	
6	R0	I	RED data signal (LSB)	
7	R1	I	RED data signal	
8	R2	I	RED data signal	
9	R3	I	RED data signal	
10	R4	I	RED data signal	
11	R5	I	RED data signal (MSB)	
12	VSS	--	GND	
13	G0	I	GREEN data signal (LSB)	
14	G1	I	GREEN data signal	
15	G2	I	GREEN data signal	
16	G3	I	GREEN data signal	
17	G4	I	GREEN data signal	
18	G5	I	GREEN data signal (MSB)	
19	VSS	--	GND	
20	B0	I	BLUE data signal(LSB)	
21	B1	I	BLUE data signal	
22	B2	I	BLUE data signal	
23	B3	I	BLUE data signal	
24	B4	I	BLUE data signal	
25	B5	I	BLUE data signal(MSB)	
26	VSS	--	GND	
27	DEN	I	Signal to settle the horizontal display position (Positive)	Note5-1
28	VCC	--	3.3V power supply	
29	VCC	--	3.3V power supply	
30	REV	I	Select horizontal and vertical scanning direction.	Note5-2
31	VSS	I	GND	
32	NC	--	No Connection	
33	VSS	I	GND	

Note 5 - 1 The horizontal display start timing is settled in accordance with a rising timing of ENAB signal. In case ENAB is fixed "Low", the horizontal start timing is determined. Don't keep ENAB "High" during operation.

5.2 Block Diagram

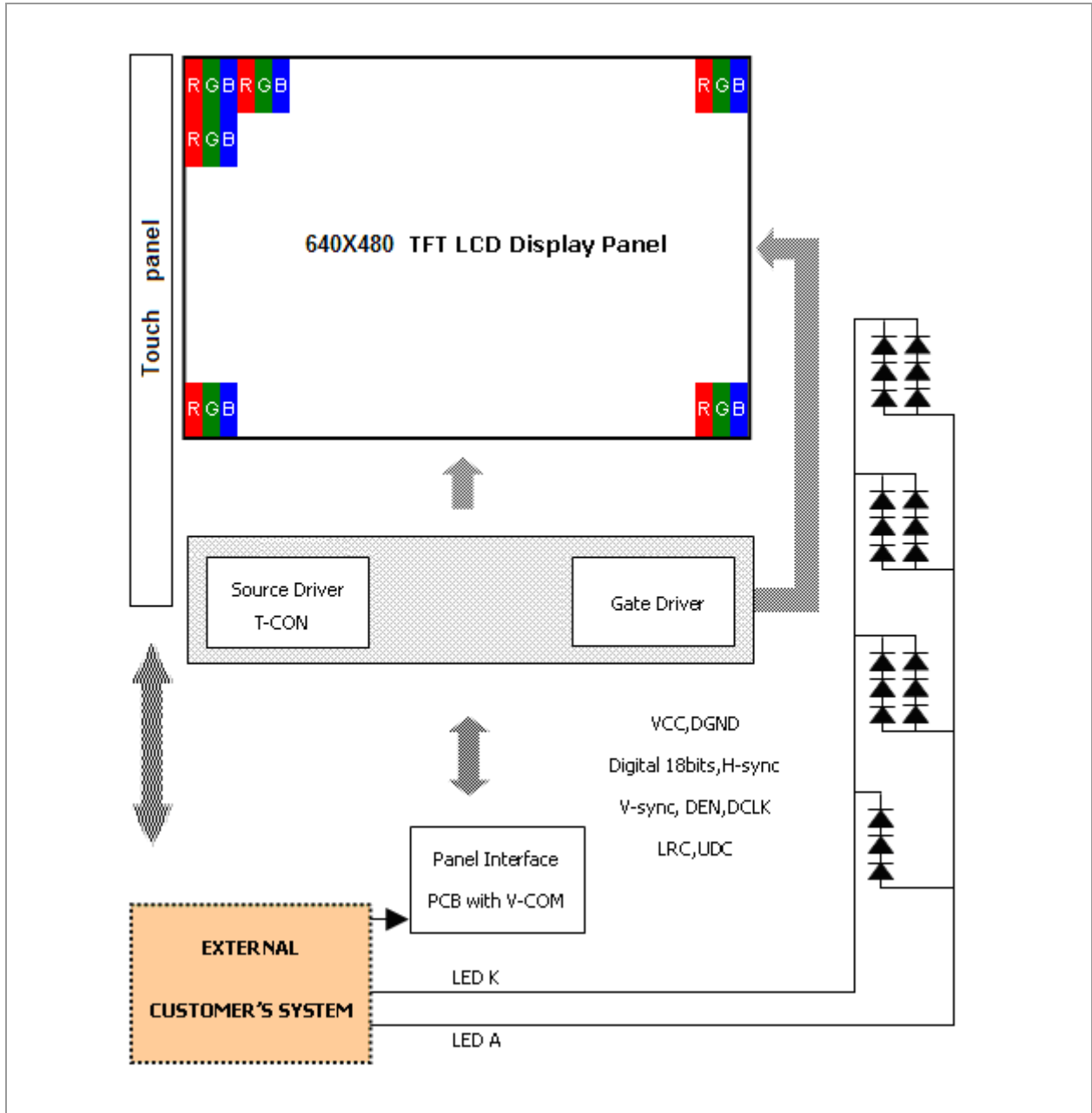

5.3 Back-light Unit (BLU)

Pin No.	Symbol	Function	Remark
1	LEDA	Power Supply for LED backlight	Red
2	LEDK	GND for LED backlight	Black

Connector: JST BHSR-02VS-1

5.4 Basic Display Color and Gray Scale

	Color & Gray Scale	Data Signal																	
		R5	R4	R3	R2	R1	R0	G5	G4	G3	G2	G1	G0	B5	B4	B3	B2	B1	B0
Basic Color	Black	0	0	0	0	0	0	0	0	0	0	0	0	0	0	0	0	0	0
	Red(0)	1	1	1	1	1	1	0	0	0	0	0	0	0	0	0	0	0	0
	Green(0)	0	0	0	0	0	0	1	1	1	1	1	1	0	0	0	0	0	0
	Blue(0)	0	0	0	0	0	0	0	0	0	0	0	0	1	1	1	1	1	1
	Cyan	0	0	0	0	0	0	1	1	1	1	1	1	1	1	1	1	1	1
	Magenta	1	1	1	1	1	1	0	0	0	0	0	0	1	1	1	1	1	1
	Yellow	1	1	1	1	1	1	1	1	1	1	1	1	0	0	0	0	0	0
	White	1	1	1	1	1	1	1	1	1	1	1	1	1	1	1	1	1	1
Red	Black	0	0	0	0	0	0	0	0	0	0	0	0	0	0	0	0	0	0
	Red(62)	0	0	0	0	0	1	0	0	0	0	0	0	0	0	0	0	0	0
	Red(61)	0	0	0	0	1	0	0	0	0	0	0	0	0	0	0	0	0	0
	:	:	:	:	:	:	:	:	:	:	:	:	:	:	:	:	:	:	:
	Red(31)	0	1	1	1	1	1	0	0	0	0	0	0	0	0	0	0	0	0
	:	:	:	:	:	:	:	:	:	:	:	:	:	:	:	:	:	:	:
	Red(1)	1	1	1	1	1	0	0	0	0	0	0	0	0	0	0	0	0	0
	Red(0)	1	1	1	1	1	1	0	0	0	0	0	0	0	0	0	0	0	0
Green	Black	0	0	0	0	0	0	0	0	0	0	0	0	0	0	0	0	0	0
	Green(62)	0	0	0	0	0	0	0	0	0	0	0	1	0	0	0	0	0	0
	Green(61)	0	0	0	0	0	0	0	0	0	0	1	0	0	0	0	0	0	0
	:	:	:	:	:	:	:	:	:	:	:	:	:	:	:	:	:	:	:
	Green(31)	0	0	0	0	0	0	0	1	1	1	1	0	0	0	0	0	0	0
	:	:	:	:	:	:	:	:	:	:	:	:	:	:	:	:	:	:	:
	Green(1)	0	0	0	0	0	0	1	1	1	1	1	0	0	0	0	0	0	0
	Green(0)	0	0	0	0	0	0	1	1	1	1	1	1	0	0	0	0	0	0
Blue	Black	0	0	0	0	0	0	0	0	0	0	0	0	0	0	0	0	0	0
	Blue(62)	0	0	0	0	0	0	0	0	0	0	0	0	0	0	0	0	0	1
	Blue(61)	0	0	0	0	0	0	0	0	0	0	0	0	0	0	0	0	1	0
	:	:	:	:	:	:	:	:	:	:	:	:	:	:	:	:	:	:	:
	Blue(31)	0	0	0	0	0	0	0	0	0	0	0	0	0	1	1	1	1	1
	:	:	:	:	:	:	:	:	:	:	:	:	:	:	:	:	:	:	:
	Blue(1)	0	0	0	0	0	0	0	0	0	0	0	0	1	1	1	1	1	0
	Blue(0)	0	0	0	0	0	0	0	0	0	0	0	0	1	1	1	1	1	1

Each basic color can be displayed in 64 gray scales from 6 bit data signals. With the combination of total 18 bit data signals, the 262,144-color display can be achieved on the screen.

6. Touch Screen Panel**6.1 Electrical Characteristics**

Item	Min.	Typ.	Max.	Unit	Note
Linearity	-	-	1.5	%	Analog X and Y directions
Terminal resistance	200	-	900	Ω	X (Glass side)
	200	-	900	Ω	Y (Film side)
Insulation resistance	20	-	-	M Ω	DC 25V
Voltage	-	5.0	15	V	DC
Chattering	-	-	15	ms	100k Ω pull-up
Transparency	-	80	-	%	Anti-glare

6.2 Mechanical & Reliability Characteristics

Item	Min.	Typ.	Max.	Unit	Note
Operation force	-	60	100	g	
Hitting Test	1,000,000	-	-	times	
Surface hardness	3	-	-	H	According to (JIS-K5400)

7. Reliability Condition

No change on display and in operation under the following test condition.

Condition: Unless otherwise specified, tests will be conducted under the following condition.

Temperature: 20±5°C.

Humidity: 65±5%RH.

Tests will be not conducted under functioning state.

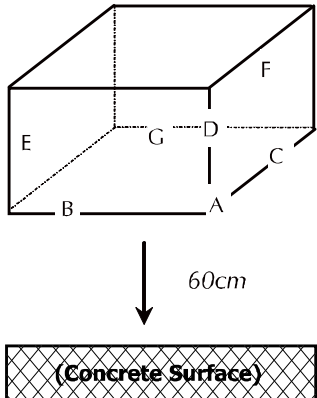
No.	Parameter	Condition	Notes
1	High Temperature Operating	70°C±2°C, 240hrs (Operation state).	-
2	Low Temperature Operating	-20°C±2°C, 240hrs (Operation state).	-
3	High Temperature Storage	80°C±2°C, 240hrs.	-
4	Low Temperature Storage	-30°C±2°C, 240hrs.	-
5	High Temperature and High Humidity Operation Test	60°C±2°C, 90%, 240hrs.	-
6	Vibration Test	Total fixed amplitude: 1.5mm. Vibration Frequency: 10~55Hz. One cycle 60 seconds to 3 direction of X, Y, Z each 15 minutes.	-
7.	Drop Test	To be measured after dropping from 60cm high on the concrete surface in packing state.  <i>Dropping method corner dropping:</i> <i>A corner: Once edge dropping.</i> <i>B, C, D edge: Once face dropping.</i> <i>E, F, G face: Once.</i>	-

8. Dimensional Outlines

