

**DISPLAY Elektronik GmbH**

**DATA SHEET**

**LCD MODULE**

**DEM 16221 SYH (solder)**

*Product Specification*

*Version : 5.2.2*

**22.09.2017**

# GENERAL SPECIFICATION

---

MODULE NO. :

## DEM 16221 SYH (solder)

CUSTOMER P/N

VERSION NO.	CHANGE DESCRIPTION	DATE
0	ORIGINAL VERSION	25.01.2001
1	ADD VERSION	30.03.2001
2	ADD VERSION	07.09.2001
3	CHANGE MODULE DRAWING	08.05.2003
4	ADD VERSION	20.04.2005
5	CHANGED MODULE DRAWING	04.05.2006
5.1.2	CHANGE IC	24.10.2008
5.1.2.1	CHANGE DESCRIPTION	19.04.2010
5.2.1	CHANGE IC	06.07.2017
5.2.2	ADD PCB DRAWING	22.09.2017

PREPARED BY: WH

DATE: 22.09.2017

APPROVED BY: MH

DATE: 22.09.2017

**CONTENTS**

1.FUNCTIONS & FEATURES .....2

2. MECHANICAL SPECIFICATIONS.....2

3. EXTERNAL DIMENSIONS .....3

4. BLOCK DIAGRAM.....4

5. PIN ASSIGNMENT.....4

6. PCB DRAWING AND DESCRIPTION .....5

7. DISPLAY DATA RAM (DDRAM) .....5

8. MAXIMUM ABSOLUTE POWER RATINGS(TA=25°C).....5

9. DC CHARACTERISTICS.....5

10. AC CHARACTERISTICS.....6

11. CHARACTER GENERATOR ROM.....8

12. INSTRUCTION TABLE.....9

13. RESET FUNCTION.....10

14. LCD MODULES HANDLING PRECAUTIONS .....11

15. OTHERS .....12

**1. FUNCTIONS & FEATURES**

MODULE NAME	FFC-CONTACTS	LCD TYPE
DEM 16221 SYH (solder)	For soldering	STN Yellow-Green Reflective Positive Mode
DEM 16221 SYH (solder/tr.)	For soldering	STN Yellow-Green Transflective Positive Mode

- Viewing Direction : 6 o'clock
- Driving Scheme : 1/16 Duty Cycle, 1/5 Bias
- Power Supply Voltage : 5.0 Volt (typ.)
- VLCD Adjustable For Best Contrast : 4.5 Volt (typ.)
- Display contents : 16x2 Characters
- Internal Memory : CGROM (13200 bits )  
: CGRAM (512 bits )  
: DDRAM (80 x 8 bits for Digits)
- Driver IC : ST7066U-0A
- Interface : Easy Interface with a 4-bit or 8-bit MPU
- Operating Temperature : -20°C to +70°C
- Storage Temperature : -25°C to +75°C

**2. MECHANICAL SPECIFICATIONS**

- Module Size : 47.00 x 44.00 x 2.50 mm
- Character Pitch : 2.25 x 4.30 mm
- Character Size : 1.95 x 3.80 mm
- Character Font : 5 x 7 dots
- Dot Size : 0.35 x 0.50 mm
- Dot Pitch : 0.40 x 0.55 mm

**3. EXTERNAL DIMENSIONS**

**3.1 DEM 16221 SYH (solder) + DEM 16221 SYH (solder/tr.)**

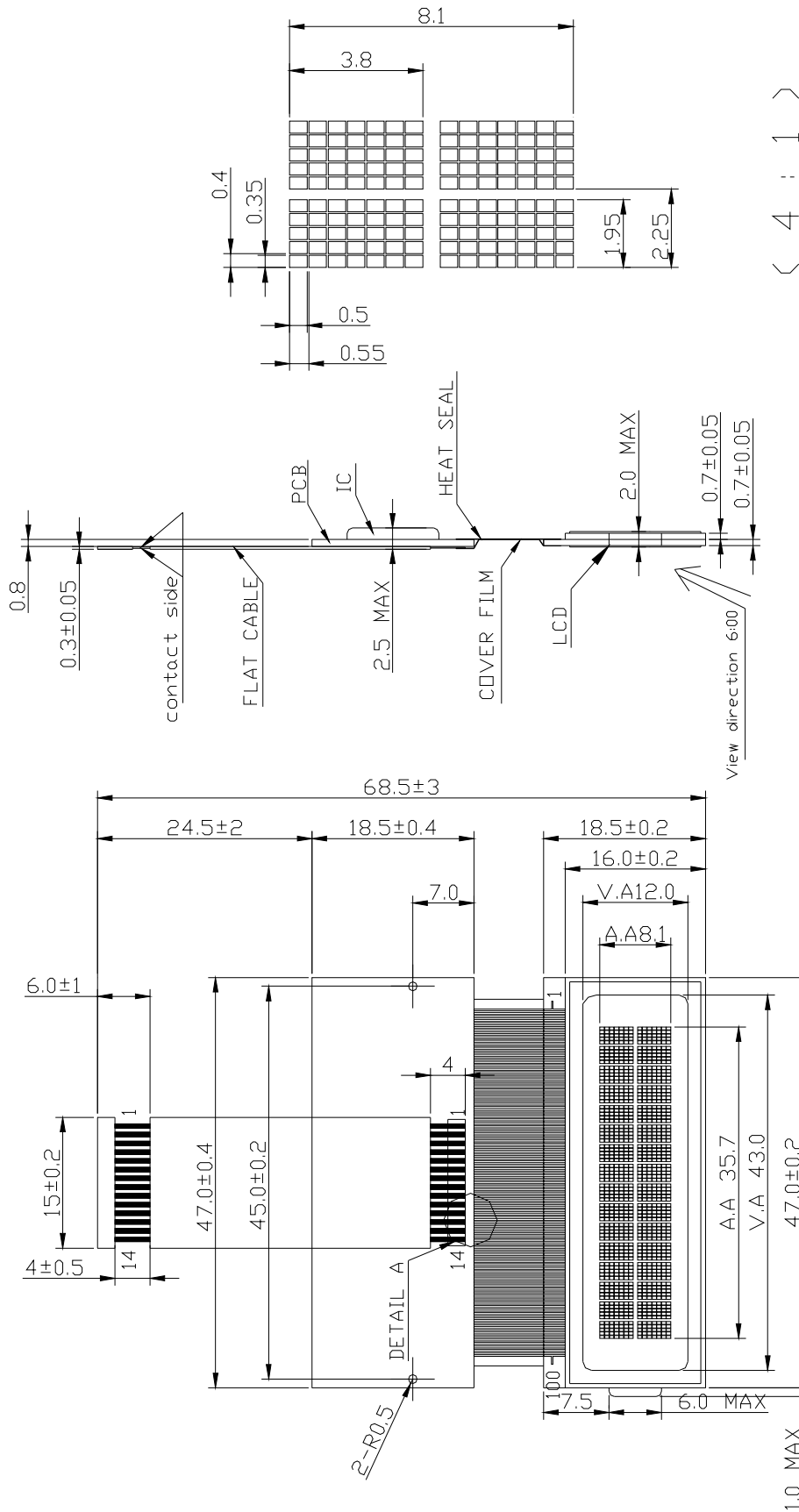

( 4 : 1 )

Remarks:  
 1, Unmarked tolerance is ±0.3,  
 2, The material comply with RoHS,  
 3, open contacts for soldering process

DETAIL A ( 3 : 1 )

**4. BLOCK DIAGRAM**

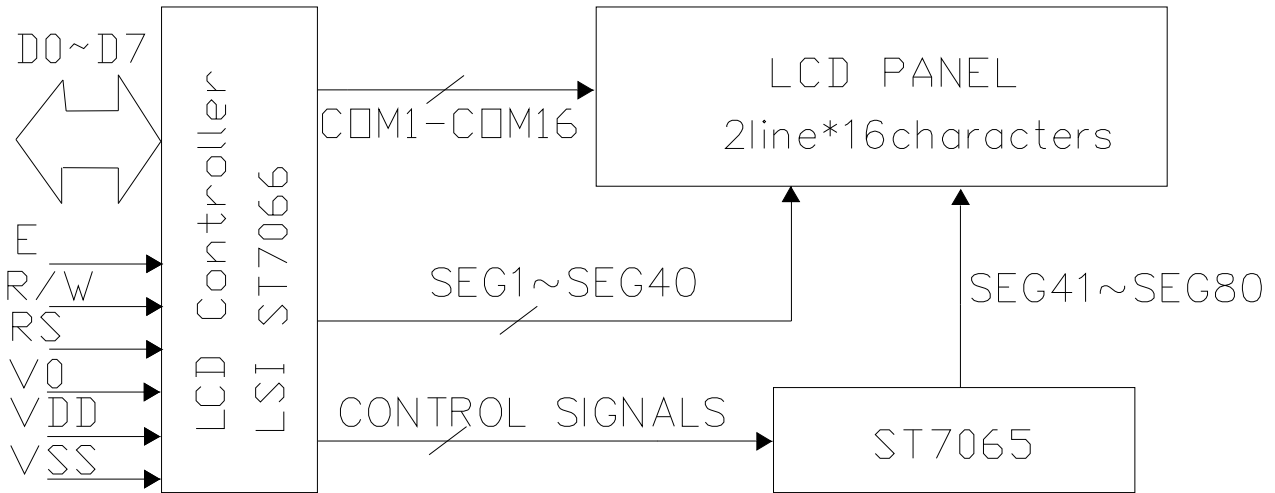

**5. PIN ASSIGNMENT**

Pin No.	Symbol	Function
1	V <sub>SS</sub>	Ground terminal of module
2	V <sub>DD</sub>	Supply terminal of module 5.0 V
3	V <sub>0</sub>	Power Supply for Liquid crystal Drive
4	RS	Register select RS = 0 (Instruction register) RS = 1 (Data register)
5	R/W	Read /Write R/W = 1 (Read) R/W = 0 (Write)
6	E	A start signal for reading or writing data
7	DB0	Bi-directional data bus, data transfer is performed once, thru DB0 to DB7, in the case of interface data. Length is 8-bits; and twice, thru DB4 to DB7 in the case of interface data length is 4-bits. Upper four bits first then lower four bits.
8	DB1	
9	DB2	
10	DB3	
11	DB4	
12	DB5	
13	DB6	
14	DB7	

**6. PCB DRAWING AND DESCRIPTION**

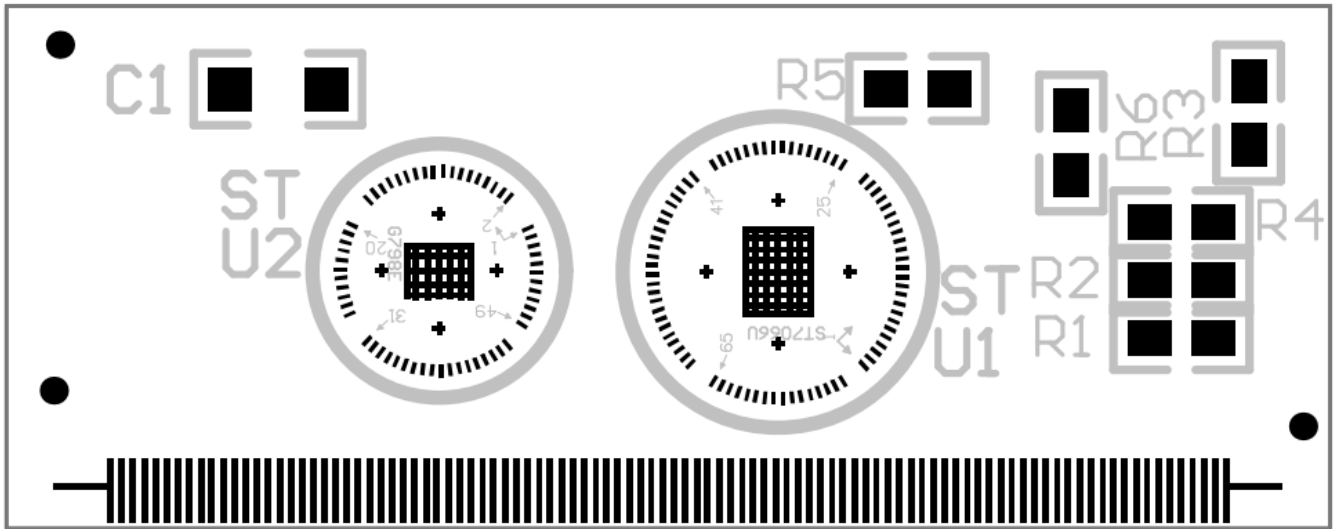

**7. DISPLAY DATA RAM (DDRAM)**

	1	2	3	4	5	6	7	8	9	10	11	12	13	14	15	16	← DISPLAY POSITION
FIRST LINE	00	01	02	03	04	05	06	07	08	09	0A	0B	0C	0D	0E	0F	← DDRAM ADDRESS
SECOND LINE	40	41	42	43	44	45	46	47	48	49	4A	4B	4C	4D	4E	4F	

**8. MAXIMUM ABSOLUTE POWER RATINGS (Ta=25°C)**

Item	Symbol	Standard value	Unit
Power Supply Voltage(1)	V <sub>DD</sub>	-0.3~+7.0	V
Power Supply Voltage(2)	V <sub>LCD</sub>	V <sub>DD</sub> -10.0~V <sub>DD</sub> +0.3	V
Input Voltage	V <sub>IN</sub>	-0.3~V <sub>DD</sub> +0.3	V
Operating Temperature	T <sub>opr</sub>	-20~+70	°C
Storage Temperature	T <sub>stg</sub>	-25~+75	°C

**9. DC CHARACTERISTICS**

(V<sub>DD</sub>=5.0V,  
Ta=25°C)

Item	Symbol	Standard Value			Test Condition	Unit
		MIN	TYP	MAX		
Operating Voltage	V <sub>DD</sub>	4.7	5	5.3	-----	V
LCD Driving Voltage	V <sub>LCD</sub>	4.2	4.5	4.8	V <sub>DD</sub> -V <sub>0</sub>	V
Supply Current	I <sub>DD</sub>	----	0.9	1.35	-----	mA

\*Note: F<sub>OSC</sub> = 270KHz, V<sub>DD</sub> = 5.0V, pin E = .L., RS, R/W, DB0 - DB7 are open, all outputs are no loads.

**10. AC CHARACTERISTICS**

Write Mode (writing data from MPU to ST7066U)

Characteristic	Symbol	Min	Type	Max	Unit	Test PIN
Enable Cycle Time	$t_c$	1200	---	---	ns	E
Enable Pulse Time	$T_{PW}$	140	---	---	ns	E
Enable Rise/Fall Time	$T_R, T_F$	---	---	25	ns	E
Address Set-up Time	$T_{AS}$	0	---	---	ns	RW,RS,E
Address Hold Time	$T_{AH}$	10	---	---	ns	RW,RS,E
Data Set-up Time	$T_{DSW}$	40	---	---	ns	DB0~DB7
Data Hold Time	$T_H$	10	---	---	ns	DB0~DB7

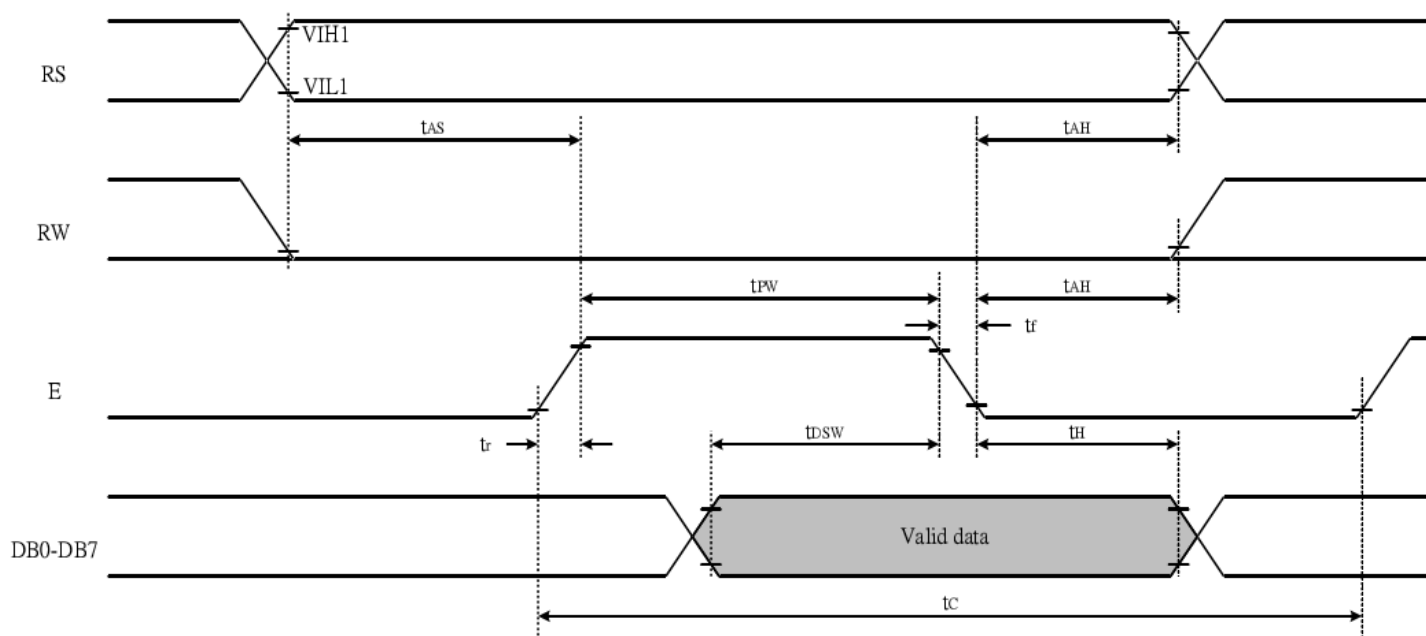



**Read Mode (Reading data from ST7066U to MPU)**

Characteristic	Symbol	Min	Type	Max	Unit	Test PIN
Enable Cycle Time	$t_c$	1200	---	---	ns	E
Enable Pulse Time	$T_{PW}$	140	---	---	ns	E
Enable Rise/Fall Time	$T_R, T_F$	---	---	25	ns	E
Address Set-up Time	$T_{AS}$	0	---	---	ns	RW,RS,E
Address Hold Time	$T_{AH}$	10	---	---	ns	RW,RS,E
Data Set-up Time	$T_{DDR}$	---	---	100	ns	DB0~DB7
Data Hold Time	$T_H$	10	---	---	ns	DB0~DB7

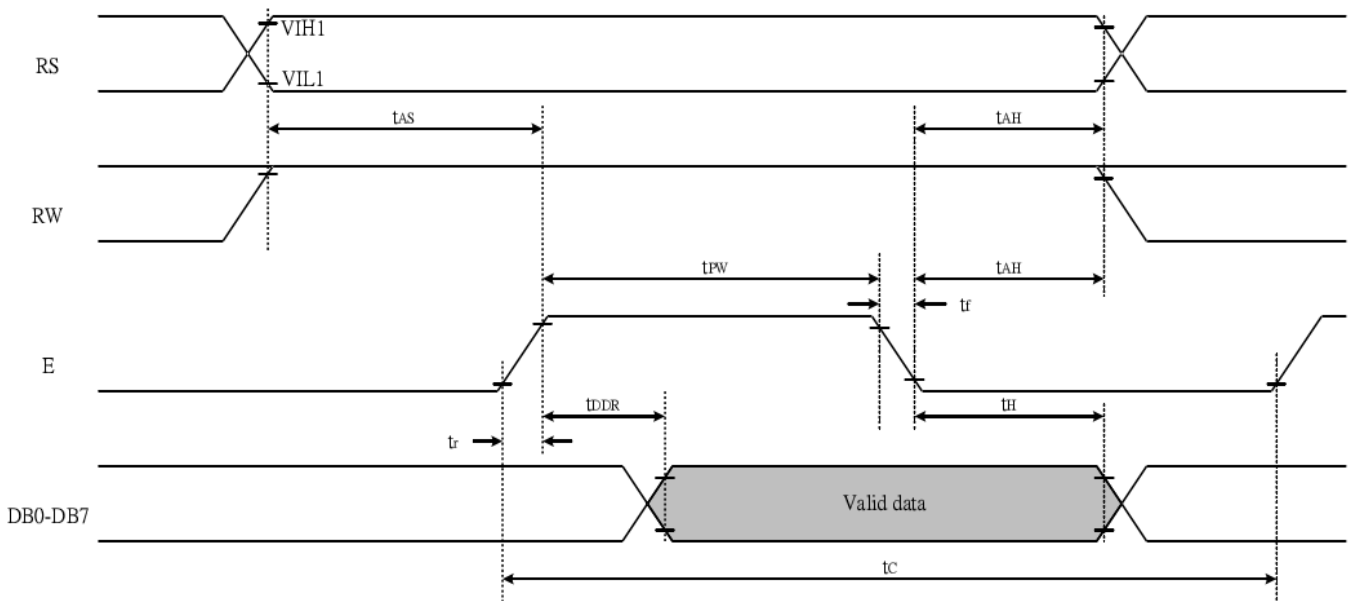

**11. CHARACTER GENERATOR ROM**

NO.7066-0A

b7-b4 b3-b0	0000	0001	0010	0011	0100	0101	0110	0111	1000	1001	1010	1011	1100	1101	1110	1111
0000	CG RAM (1)			0	1	2	3	4				一	二	三	四	五
0001	(2)		!	1	A	Q	a	q			二	フ	チ	△	△	q
0010	(3)		"	2	B	R	b	r			フ	イ	ウ	×	ρ	θ
0011	(4)		#	3	C	S	c	s			┘	ウ	チ	セ	ε	ω
0100	(5)		\$	4	D	T	d	t			√	工	ト	ト	μ	Ω
0101	(6)		%	5	E	U	e	u			*	オ	カ	工	ε	Ω
0110	(7)		&	6	F	V	f	v			マ	カ	ニ	ヨ	ρ	Σ
0111	(8)		'	7	G	W	g	w			マ	キ	ク	マ	g	Σ
1000	(1)		(	8	H	X	h	x			レ	ク	カ	ウ	ε	Σ
1001	(2)		)	9	I	Y	i	y			ロ	ク	ル	ウ	ε	Σ
1010	(3)		*	#	J	Z	j	z			エ	コ	ン	ク	J	Σ
1011	(4)		+	;	K	L	k	l			オ	サ	ヒ	ロ	ε	Σ
1100	(5)		,	<	L	¥	l	l			カ	シ	フ	フ	φ	Σ
1101	(6)		-	=	M	^	m	^			ユ	ズ	△	△	ε	Σ
1110	(7)		.	>	N	^	n	^			ヨ	セ	ホ	△	△	Σ
1111	(8)		/	?	O	_	o	_			ヨ	ソ	マ	△	△	Σ

**12. INSTRUCTION TABLE**

Command	RS	R/W	DB7	DB6	DB5	DB4	DB3	DB2	DB1	DB0	Execution time (fosc=270KHz)	Remark
Clear Display	0	0	0	0	0	0	0	0	0	1	1.52ms	Write"20H" to DDRAM. And set DDRAM address to "00H" from AC
Return home	0	0	0	0	0	0	0	0	1	x	1.52ms	Set DDRAM address to "00H" from AC and return cursor to its original position if shifted. The contents of DDRAM are not changed.
Entry mode Set	0	0	0	0	0	0	0	1	I/D	S	37us	Sets cursor move direction and specifies display shift. These operations are performed during data write and read.
Display on/off control	0	0	0	0	0	0	1	D	C	B	37us	D=1: entire display on C=1: cursor on B=1: cursor position on
Cursor or Display Shift	0	0	0	0	0	1	S/C	R/L	x	x	37us	Set cursor moving and display shift control bit, and the direction, without changing DDRAM data.
function Set	0	0	0	0	1	DL	N	F	x	x	37us	DL: interface data is 8/4 bits N: number of line is 2/1 F: font size is 5x11/5x8
Set CGRAM address	0	0	0	1	AC5	AC4	AC3	AC2	AC1	AC0	37us	Set CGRAM address in address counter
Set DDRAM address	0	0	1	AC6	AC5	AC4	AC3	AC2	AC1	AC0	37us	Set DDRAM address in address counter
Read busy flag& address	0	1	BF	AC6	AC5	AC4	AC3	AC2	AC1	AC0	0us	Whether during internal operation or not can be known by reading BF. The contents of address counter can also be read.
Write data to RAM	1	0	D7	D6	D5	D4	D3	D2	D1	D0	37us	Write data into internal RAM (DDRAM/CGRAM)
Read data from RAM	1	1	D7	D6	D5	D4	D3	D2	D1	D0	37us	Read data from internal RAM (DDRAM / CGRAM)

**Note:**

Be sure the ST7066U is not in the busy state (BF=00) before sending an instruction from the MPU to the ST7066U. If an instruction is sent without checking the busy flag, the time between the first instruction and next instruction will take much longer than the instruction time itself. Refer to instruction table for the list of each instruction execution time.

13. RESET FUNCTION

- 8-bit interface ( $f_{osc} = 270KHz$ )

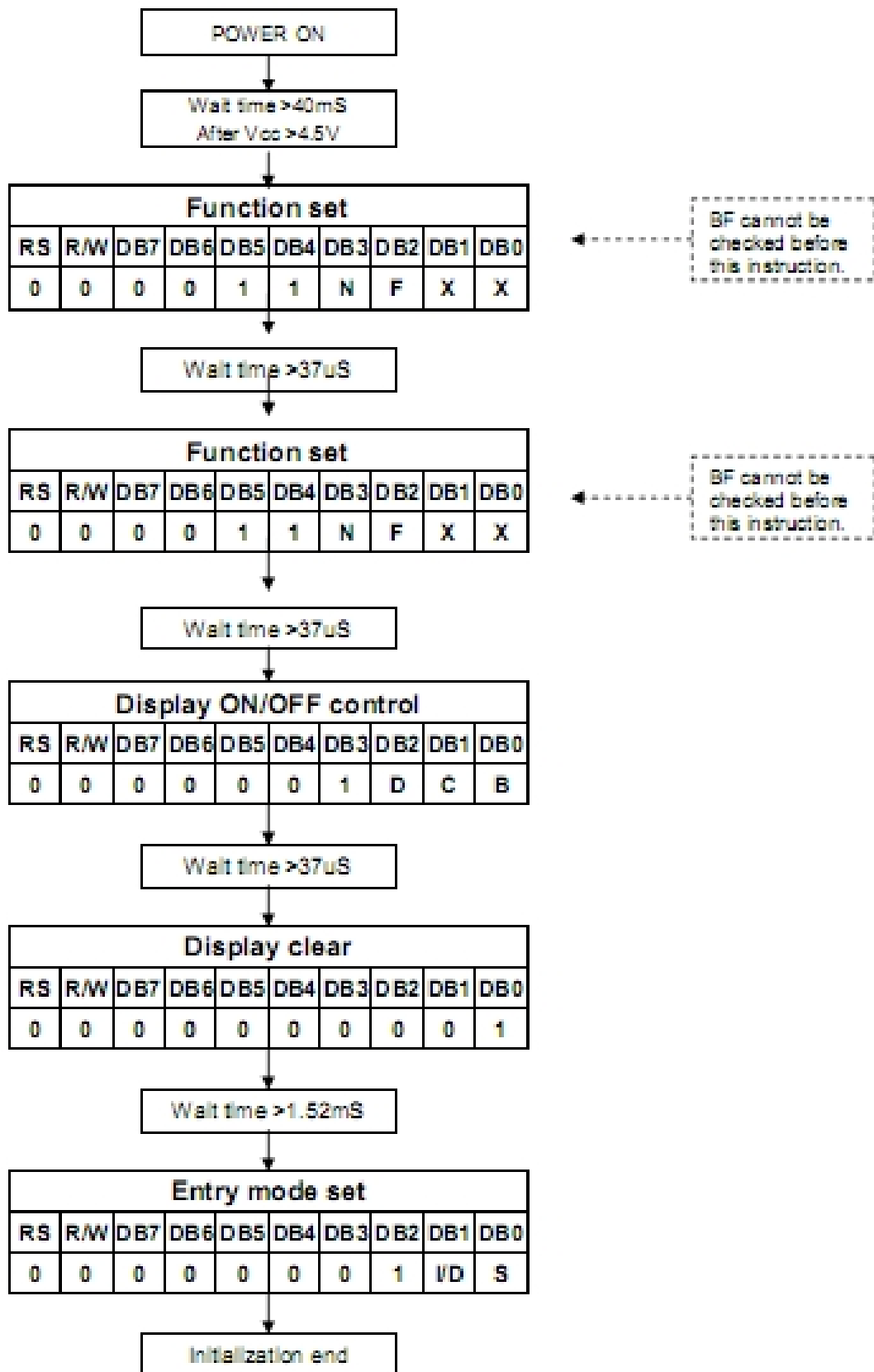

● 4-bit Interface (fosc=270KHz)

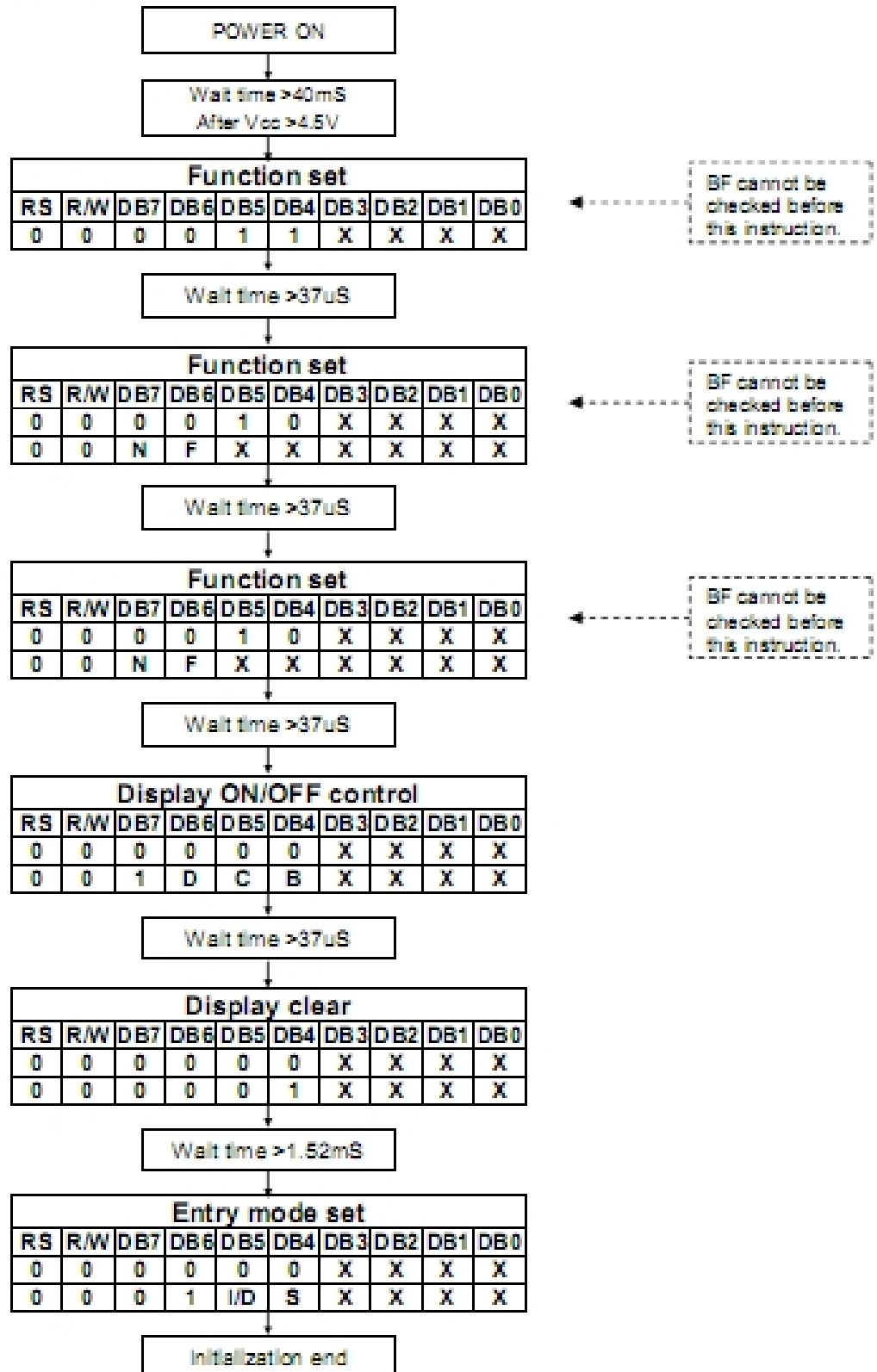

**14. LCD MODULES HANDLING PRECAUTIONS**

- Please remove the protection foil of polarizer before using.
- The display panel is made of glass. Do not subject it to a mechanical shock by dropping it from a high place, etc.
- If the display panel is damaged and the liquid crystal substance inside it leaks out, do not get any in your mouth. If the substance come into contact with your skin or clothes promptly wash it off using soap and water.
- Do not apply excessive force to the display surface or the adjoining areas since this may cause the color tone to vary.
- The polarizer covering the display surface of the LCD module is soft and easily scratched. Handle this polarize carefully.
- To prevent destruction of the elements by static electricity, be careful to maintain an optimum work environment.
  - Be sure to ground the body when handling the LCD module.
  - Tools required for assembly, such as soldering irons, must be properly grounded.
  - To reduce the amount of static electricity generated, do not conduct assembly and other work under dry conditions.
  - The LCD module is coated with a film to protect the display surface. Exercise care when peeling off this protective film since static electricity may be generated.
- Storage precautions  
When storing the LCD modules, avoid exposure to direct sunlight or to the light of fluorescent lamps. Keep the modules in bags designed to prevent static electricity charging under low temperature / normal humidity conditions (avoid high temperature / high humidity and low temperatures below 0°C). Whenever possible, the LCD modules should be stored in the same conditions in which they were shipped from our company.

**15. OTHERS**

- Liquid crystals solidify at low temperature (below the storage temperature range) leading to defective orientation of liquid crystal or the generation of air bubbles (black or white). Air bubbles may also be generated if the module is subjected to a strong shock at a low temperature.
- If the LCD modules have been operating for a long time showing the same display patterns may remain on the screen as ghost images and a slight contrast irregularity may also appear. Abnormal operating status can be resumed to be normal condition by suspending use for some time. It should be noted that this phenomena does not adversely affect performance reliability.
- To minimize the performance degradation of the LCD modules resulting from caused by static electricity, etc. exercise care to avoid holding the following sections when handling the modules:
  - Exposed area of the printed circuit board
  - Terminal electrode sections