

Display Elektronik GmbH

DATA SHEET

TFT- MODULE

DEM 550100A MMH-PW-N

4,4" MONO-TFT

Product Specification

Ver.: 1

14.05.2019

Revision History

Revision	Date	Originator	Detail	Remarks
0	13.05.2019	ZDT	Initial Release	
1	14.05.2019	MHI	Modify Outline Drawing	P22

Table of Contents

No.	Item	Page
1.	General Description	4
2.	Module Parameter	4
3.	Absolute Maximum Ratings	4
4.	DC Characteristics	5
5.	Backlight Characteristic	5
5.1.	Backlight Characteristic	5
5.2.	Backlighting circuit	5
6.	Optical Characteristics	6
6.1.	Optical Characteristics	6
6.2.	Definition of Response Time	6
6.3.	Definition of Contrast Ratio	7
6.4.	Definition of Viewing Angles.....	7
6.5.	Definition of Color Appearance	8
6.6.	Definition of Surface Luminance, Uniformity and Transmittance.....	8
7.	Block Diagram and Power Supply	9
8.	Interface Pins Definition	10
9.	AC Characteristics	11
9.1.	System Bus Timing for 8080 Series MPU.....	11
10.	Quality Assurance	12
10.1.	Purpose.....	12
10.2.	Standard for Quality Test.....	12
10.3.	Nonconforming Analysis & Disposition	12
10.4.	Agreement Items.....	12
10.5.	Standard of the Product Visual Inspection	12
10.6.	Inspection Specification	13
10.7.	Classification of Defects.....	17
10.8.	Identification/marketing criteria	17
10.9.	Packing	17
11.	Reliability Specification	18
12.	Precautions and Warranty	19
12.1.	Safety	19
12.2.	Handling.....	19
12.3.	Storage.....	19
12.4.	Metal Pin (Apply to Products with Metal Pins)	19
12.5.	Operation	20
12.6.	Static Electricity	20
12.7.	Limited Warranty	20
13.	Outline Drawing	21

1. General Description

The specification is a transmissive type color active matrix liquid crystal display (LCD) which uses amorphous thin film transistor (TFT) as switching devices. This product is composed of a TFT-LCD panel, driver Ics and a backlight unit.

2. Module Parameter

Features	Details	Unit
Display Size(Diagonal)	4.4"	
Display Mode	Transmissive / Normally Black	
LCD Type	a-Si TFT	
Resolution	550 x 100	Pixels
View Direction	FULL VIEW	Best Image
Module Outline	122.30 x31.80 x 2.60 (Note1)	mm
Active Area	110.00 x 20.00	mm
Pixel Pitch	0.200 x 0.200	mm
Pixel Arrangement	Mono Stripe	
Polarizer Surface Treatment	Anti-glare	
Interface	8-bit 8080 Interface	
Driver IC	ST7511	-
With or Without Touch Panel	Without	
Operating Temperature	-20~70	°C
Storage Temperature	-30~80	°C
Weight	TBD	g

Note 1: Exclusive hooks, posts, FFC/FPC tail etc.

3. Absolute Maximum Ratings

V_{ss}=0V, Ta=25°C

Item	Symbol	Min.	Max.	Unit
Supply Voltage	VCC	-0.3	6.0	V
Storage Temperature	T _{stg}	-30	+80	°C
Operating Temperature	T _{op}	-20	+70	°C

Note 1: If Ta below 50°C, the maximal humidity is 90%RH, if Ta over 50°C, absolute humidity should be less than 60%RH.

Note 2: The response time will be extremely slow when the operating temperature is around -10 °C, and the back ground will become darker at high temperature operating.

4. DC Characteristics

Item	Symbol	Min.	Typ.	Max.	Unit	
Supply Voltage	VCC	2.7	3.3	5.5	V	
Logic Low Input Voltage	V _{IL}	GND	-	0.2*VCC	V	
Logic High Input Voltage	V _{IH}	0.8*VCC	-	VCC	V	
Logic Low Output Voltage	V _{OL}	GND	-	0.2*VCC	V	
Logic High Output Voltage	V _{OH}	0.8*VCC	-	VCC	V	
Current Consumption All White	Logic	I _{CC+} I _{IN}	-	TBD	-	mA
	Analog					

5. Backlight Characteristic

5.1. Backlight Characteristic

Item	Symbol	Condition	Min.	Typ.	Max.	Unit
Forward Voltage	V _F	T _a =25 °C, I _F =20mA/LED	16.8	19.2	20.4	V
Forward Current	I _F	T _a =25 °C, V _F =3.2V/LED	-	40	-	mA
Power Dissipation	P _D	-	-	768	-	mW
Uniformity	Avg	-	-	80	-	%
LED Lifetime (25 °C)	-	-	20,000	30,000	-	Hrs
Drive Method	Constant current					
LED Configuration	12 White LEDs (6 LEDs in string and 2 groups in parallel)					

Note1: LED life time defined as follows: The final brightness is at 50% of original brightness.
 The environmental conducted under ambient air flow, at T_a=25 °C ± 2 °C, 60%RH± 5%, I_F=20mA/LED.

5.2. Backlighting circuit

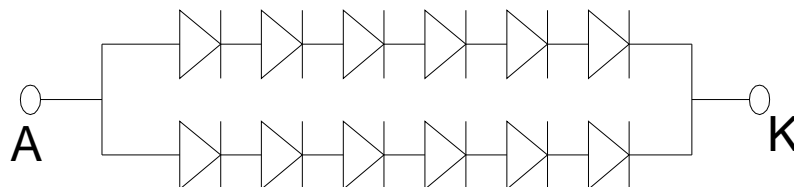

6. Optical Characteristics

6.1. Optical Characteristics

Ta=25°C, VCC=3.3V

	Item	Symbol	Condition	Specification			Unit	
				Min.	Typ.	Max.		
Backlight On (Transmissive Mode)	Luminance on TFT($I_f=20\text{mA/LED}$)	Lv		240	300	-	cd/m ²	
	Contrast Ratio(See 6.3)	CR		-	TBD	-		
	Response Time (See 6.2)	T _R			-	TBD	-	ms
		T _F						
	Chromaticity Transmissive (See 6.5)	Red	X _R	Backlight is on	-	TBD	-	-
			Y _R		-	TBD	-	-
		Green	X _G		-	TBD	-	-
			Y _G		-	TBD	-	-
		Blue	X _B		-	TBD	-	-
			Y _B		-	TBD	-	-
	White	X _W	-	TBD	-	-		
		Y _W	-	TBD	-	-		
	Viewing Angle (See 6.4)	Horizontal	θ _{x+}	Center CR≥10	-	80	-	Deg.
			θ _{x-}		-	80	-	
Vertical		φ _{Y+}	-		80	-		
		φ _{Y-}	-		80	-		

6.2. Definition of Response Time

6.2.1. Normally Black Type (Negative)

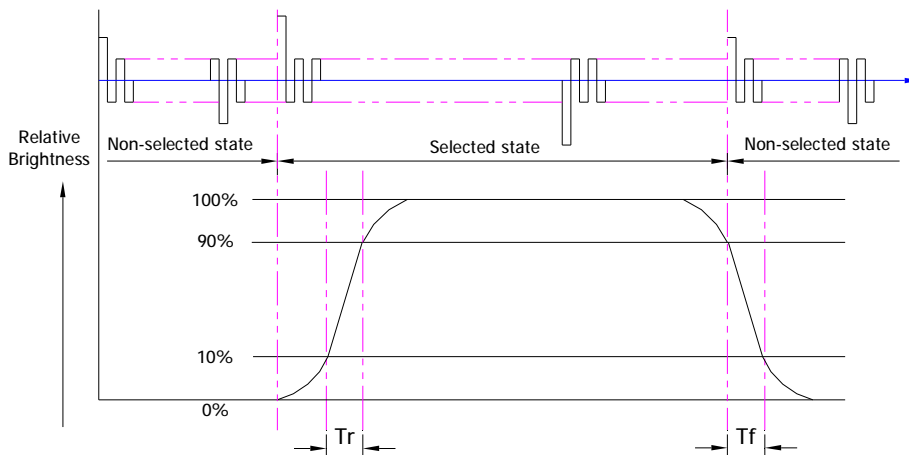

Tr is the time it takes to change from non-selected stage with relative luminance 10% to selected state with relative luminance 90%;

Tf is the time it takes to change from selected state with relative luminance 90% to non-selected state with relative luminance 10%.

Note: Measuring machine: LCD-5100

6.2.2. Normally White Type (Positive)

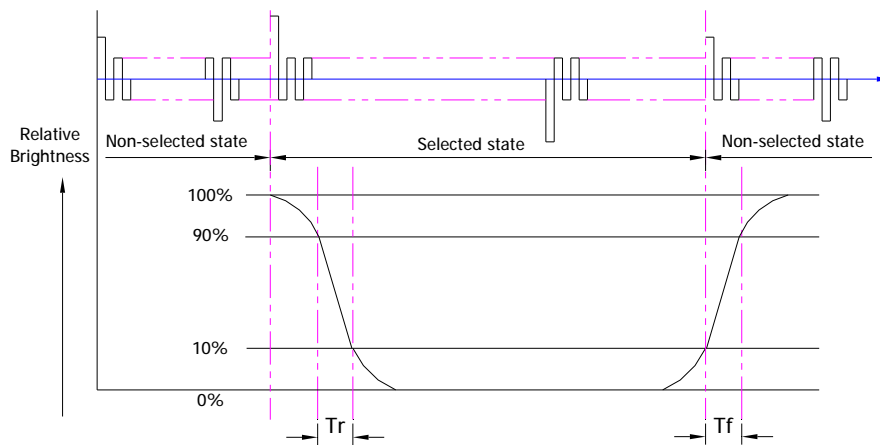

Tr is the time it takes to change from non-selected stage with relative luminance 90% to selected state with relative luminance 10%;

Tf is the time it takes to change from selected state with relative luminance 10% to non-selected state with relative luminance 90%;

Note: Measuring machine: LCD-5100 or EQUI

6.3. Definition of Contrast Ratio

Contrast is measured perpendicular to display surface in reflective and transmissive mode. The measurement condition is:

Measuring Equipment	Eldim or Equivalent
Measuring Point Diameter	3mm//1mm
Measuring Point Location	Active Area centre point
Test Pattern	A: All Pixels white
	B: All Pixel black
Contrast Setting	Maximum

Definitions: CR (Contrast) = Luminance of White Pixel / Luminance of Black Pixel

6.4. Definition of Viewing Angles

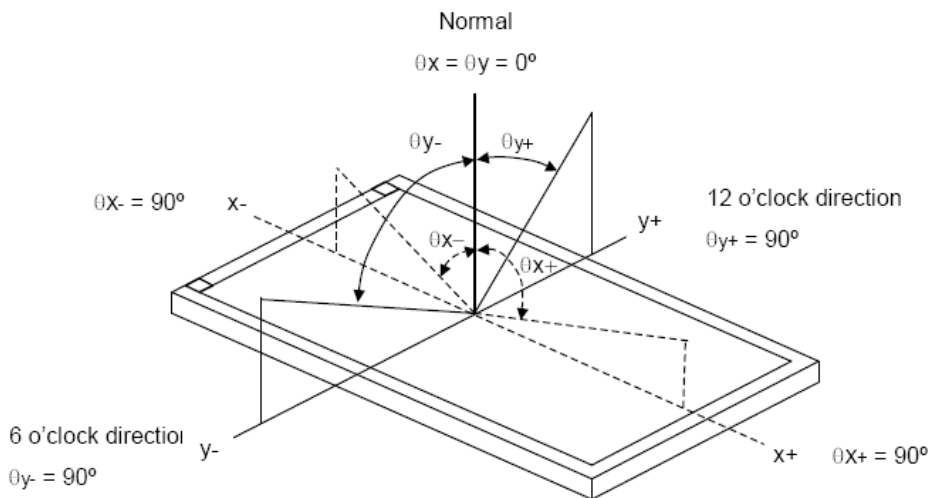

Measuring machine: LCD-5100 or EQUI

6.5. Definition of Color Appearance

R, G, B and W are defined by (x, y) on the IE chromaticity diagram

NTSC=area of RGB triangle/area of NTSC triangleX100%

Measuring picture: Red, Green, Blue and White (Measuring machine: BM-7)

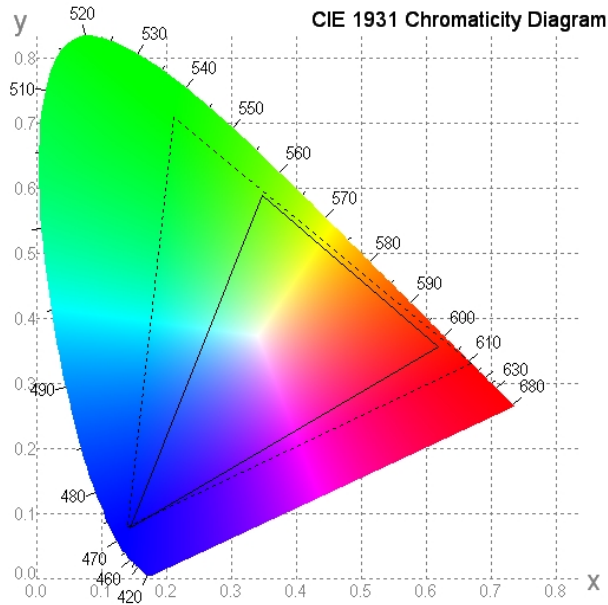

6.6. Definition of Surface Luminance, Uniformity and Transmittance

Using the transmissive mode measurement approach, measure the white screen luminance of the display panel and backlight.

6.6.1. Surface Luminance: $L_v = \text{average} (L_{P1}:L_{P9})$

6.6.2. Uniformity = $\text{Minimal} (L_{P1}:L_{P9}) / \text{Maximal} (L_{P1}:L_{P9}) * 100\%$

6.6.3. Transmittance = $L_v \text{ on LCD} / L_v \text{ on Backlight} * 100\%$

Note: Measuring machine: BM-7

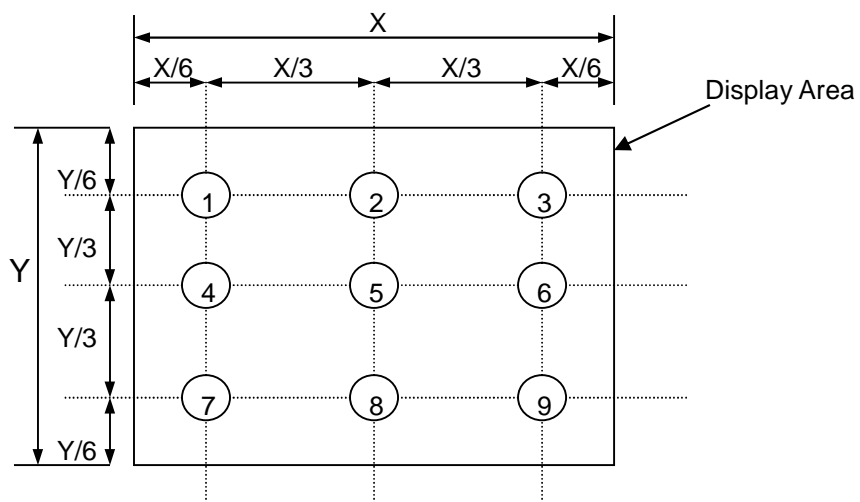

7. Block Diagram and Power Supply

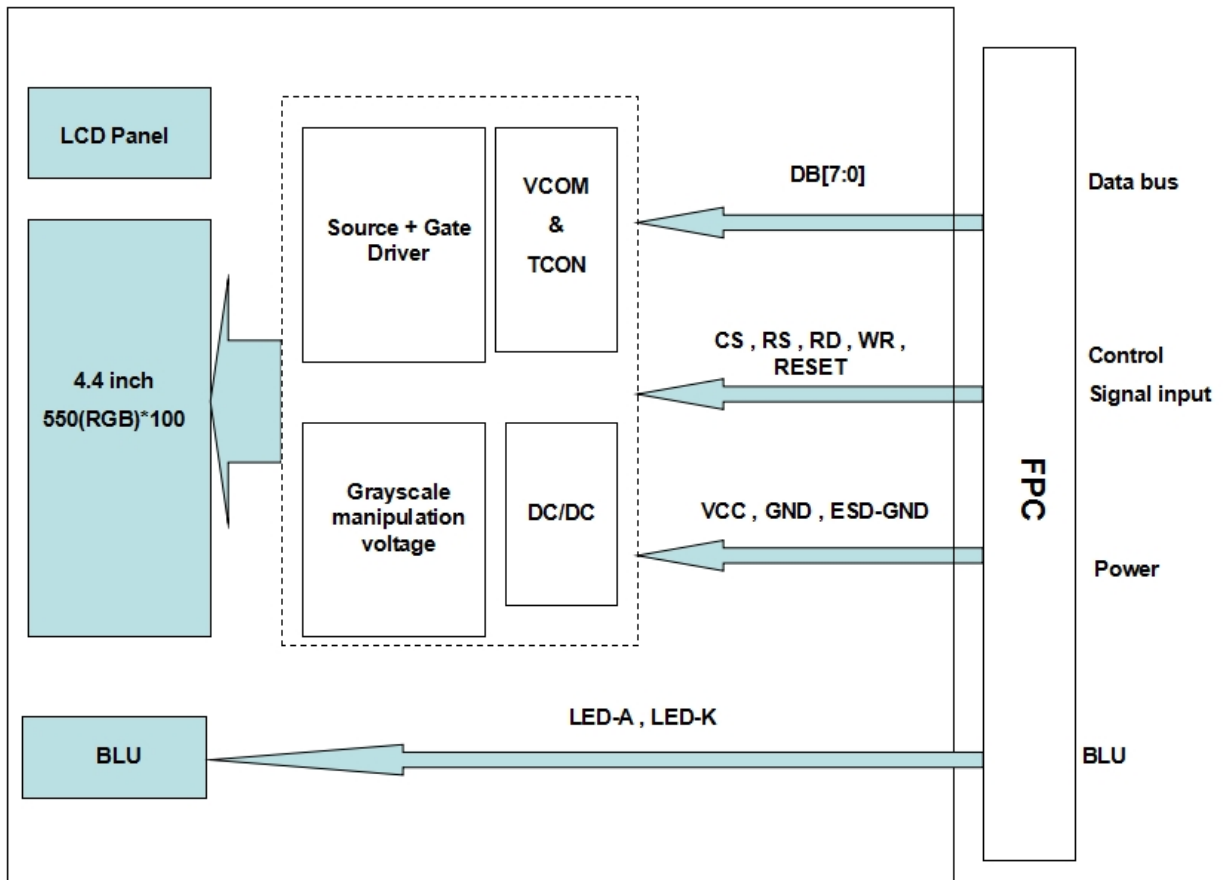

8. Interface Pins Definition

No.	Symbol	Function	Remark
1	GND	Ground.	
2	VCC	Power supply.	
3	VCC	Power supply.	
4	GND	Ground.	
5	CS	Chip select input pin.	
6	TE	Tearing effect output pin.	
7	RESET	Reset input pin.	
8	RS	Data/Command identification pin. RS=A0.	
9	GND	Ground.	
10	RD	Read enable input pin.	
11	WR	Write enable input pin.	
12	GND	Ground.	
13	DB0	Data bus.	
14	DB1	Data bus.	
15	GND	Ground.	
16	DB2	Data bus.	
17	DB3	Data bus.	
18	GND	Ground.	
19	DB4	Data bus.	
20	DB5	Data bus.	
21	GND	Ground.	
22	DB6	Data bus.	
23	DB7	Data bus.	
24	GND	Ground.	
25	LED-A	LED Cathode.	
26	LED-A	LED Cathode.	
27	LED-K	LED Anode.	
28	LED-K	LED Anode.	
29	LED-K	LED Anode.	
30	LED-K	LED Anode.	
31	ESD-GND	Ground.	
32	ESD-GND	Ground.	

9. AC Characteristics

9.1. System Bus Timing for 8080 Series MPU

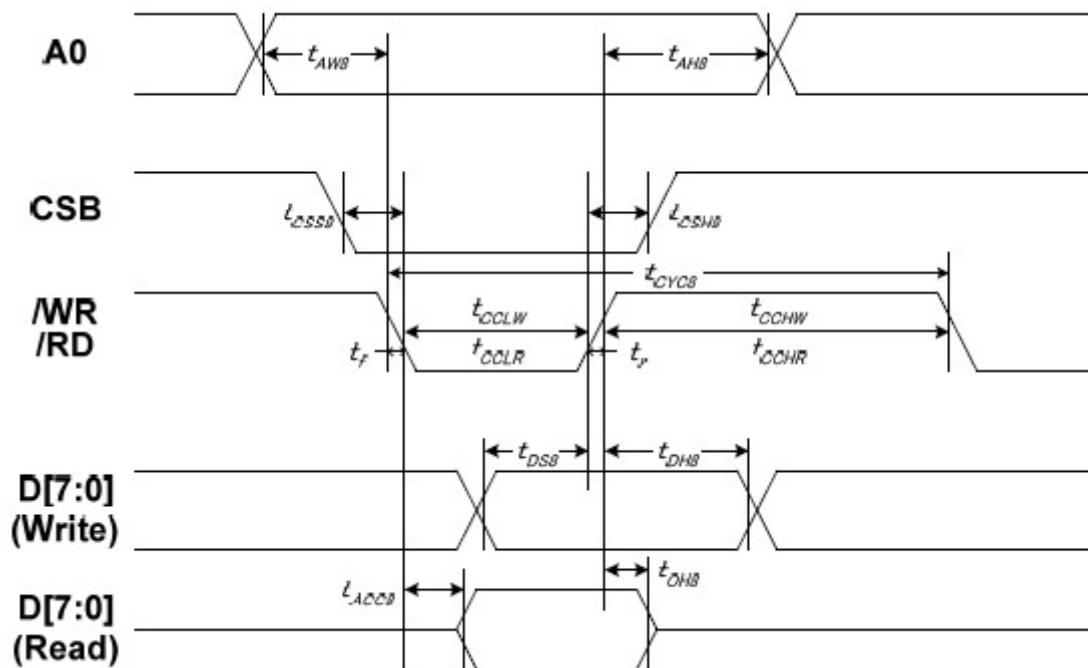

Item	Signal	Symbol	Condition	Min.	Max.	Unit
Address setup time	A0	tAW8		10	—	ns
Address hold time		tAH8		0	—	
System cycle time		tCYC8		1100	—	
/WR L pulse width (WRITE)	/WR	tCCLW		500	—	
/WR H pulse width (WRITE)		tCCHW		500	—	
/RD L pulse width (READ)	/RD	tCCLR		950	—	
/RD H pulse width (READ)		tCCHR		500	—	
CSB setup time	CSB	tCSS8		100	—	
CSB hold time		tCSH8		100	—	
WRITE Data setup time	D[7:0]	tDS8		200	—	
WRITE Data hold time		tDH8		50	—	
READ access time	D[7:0]	tACC8	CL = 100 pF	—	950	
READ Output disable time		tOH8	CL = 100 pF	5	200	

Note:

1. The input signal rise time and fall time (t_r , t_f) is specified at 15 ns or less. When the system cycle time is extremely fast, $(t_r + t_f) \leq (t_{CYC8} - t_{CCLW} - t_{CCHW})$ for $(t_r + t_f) \leq (t_{CYC8} - t_{CCLR} - t_{CCHR})$ are specified.
2. All timing is specified using 20% and 80% of VDD1 as the reference.
3. tCCLW and tCCLR are specified as the overlap between CSB being "L" and /WR and /RD being at the "L" level. CSB and /WR (or /RD) cannot act at the same time and CSB should be 100ns wider than /WR (or /RD).

10. Quality Assurance

10.1.Purpose

This standard for Quality Assurance assures the quality of LCD module products supplied to customer.

10.2.Standard for Quality Test

10.2.1. Sampling Plan:

GB2828.1-2012

Single sampling, general inspection level II

10.2.2. Sampling Criteria:

Visual inspection: AQL 1.5%

Electrical functional: AQL 0.65%.

10.2.3. Reliability Test:

Detailed requirement refer to Reliability Test Specification.

10.3.Nonconforming Analysis & Disposition

10.3.1. Nonconforming analysis:

10.3.1.1. Customer should provide overall information of non-conforming sample for their complaints.

10.3.1.2. After receipt of detailed information from customer, the analysis of nonconforming parts usually should be finished in one week.

10.3.1.3. If cannot finish the analysis on time, customer will be notified with the progress status.

10.3.2. Disposition of nonconforming:

10.3.2.1. Non-conforming product over PPM level will be replaced.

10.3.2.2. The cause of non-conformance will be analyzed. Corrective action will be discussed and implemented.

10.4.Agreement Items

Shall negotiate with customer if the following situation occurs:

10.4.1. There is any discrepancy in standard of quality assurance.

10.4.2. Additional requirement to be added in product specification.

10.4.3. Any other special problem.

10.5.Standard of the Product Visual Inspection

10.5.1. Appearance inspection:

10.5.1.1. The inspection must be under illumination about 1000 – 1500 lx, and the distance of view must be at 30cm ± 2cm.

10.5.1.2. The viewing angle should be 45° from the vertical line without reflection light or follows customer's viewing angle specifications.

10.5.1.3. Definition of area: A Zone: Active Area, B Zone: Viewing Area,

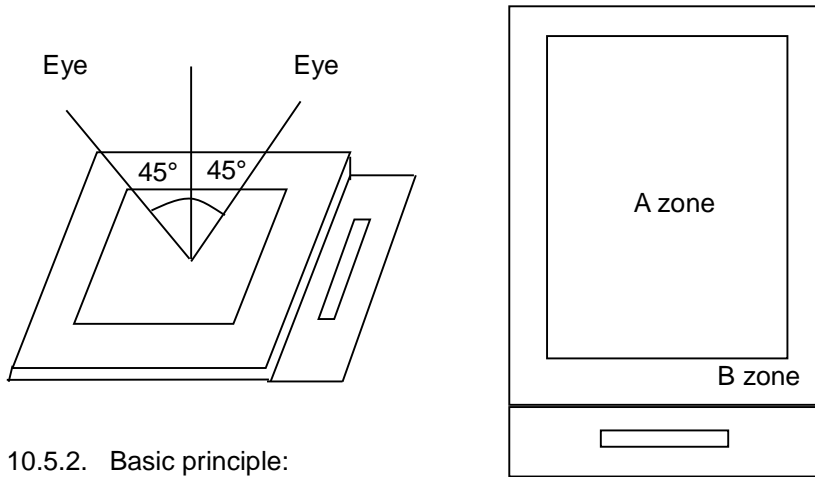

10.5.2. Basic principle:

10.5.2.1. A set of sample to indicate the limit of acceptable quality level must be discussed by both us and customer when there is any dispute happened.

10.5.2.2. New item must be added on time when it is necessary.

10.6. Inspection Specification

No.	Item	Criteria (Unit: mm)																		
01	Black / White spot Foreign material (Round type) Pinholes Stain Particles inside cell. (Minor defect)	<p>$\phi = (a + b) / 2$</p> <p>Distance between 2 defects should more than 3mm apart.</p> <table border="1"> <thead> <tr> <th>Size</th> <th>Area</th> <th>Acc. Qty</th> </tr> </thead> <tbody> <tr> <td>$\phi \leq 0.10$</td> <td></td> <td>Ignore</td> </tr> <tr> <td>$0.10 < \phi \leq 0.15$</td> <td></td> <td>2</td> </tr> <tr> <td>$0.15 < \phi \leq 0.25$</td> <td></td> <td>1</td> </tr> <tr> <td>$0.25 < \phi$</td> <td></td> <td>0</td> </tr> <tr> <td>Total</td> <td></td> <td>2 no include $\phi \leq 0.10$</td> </tr> </tbody> </table>	Size	Area	Acc. Qty	$\phi \leq 0.10$		Ignore	$0.10 < \phi \leq 0.15$		2	$0.15 < \phi \leq 0.25$		1	$0.25 < \phi$		0	Total		2 no include $\phi \leq 0.10$
Size	Area	Acc. Qty																		
$\phi \leq 0.10$		Ignore																		
$0.10 < \phi \leq 0.15$		2																		
$0.15 < \phi \leq 0.25$		1																		
$0.25 < \phi$		0																		
Total		2 no include $\phi \leq 0.10$																		
02	Electrical Defect (Minor defect)	<table border="1"> <thead> <tr> <th></th> <th>Display Area</th> <th>Total</th> <th rowspan="3">Note1</th> </tr> </thead> <tbody> <tr> <td>Bright dot</td> <td>0</td> <td>0</td> </tr> <tr> <td>Dark dot</td> <td>$N \leq 2$</td> <td>$N \leq 2$</td> </tr> <tr> <td>Total dot</td> <td>$N \leq 2$</td> <td>$N \leq 2$</td> <td></td> </tr> <tr> <td>Mura</td> <td colspan="2">Not visible through 5% ND filters.</td> <td>Note 2</td> </tr> </tbody> </table> <p>Remark: 1. Bright dot caused by scratch and foreign object accords to item 1.</p>		Display Area	Total	Note1	Bright dot	0	0	Dark dot	$N \leq 2$	$N \leq 2$	Total dot	$N \leq 2$	$N \leq 2$		Mura	Not visible through 5% ND filters.		Note 2
	Display Area	Total	Note1																	
Bright dot	0	0																		
Dark dot	$N \leq 2$	$N \leq 2$																		
Total dot	$N \leq 2$	$N \leq 2$																		
Mura	Not visible through 5% ND filters.		Note 2																	

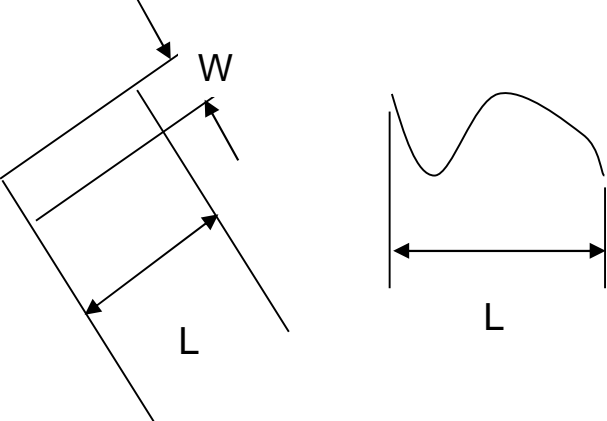
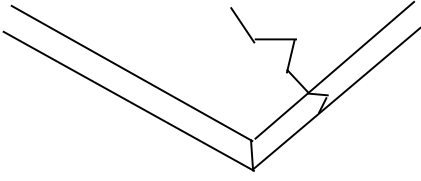
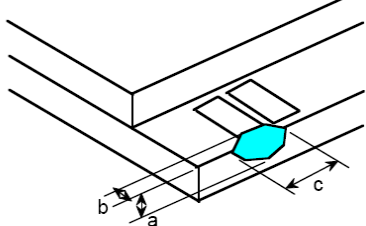
<p>03</p>	<p>Black and White line Scratch Foreign material (Line type) (Minor defect)</p>	 <table border="1" data-bbox="614 721 1240 1028"> <thead> <tr> <th>Length</th> <th>Width</th> <th>Acc. Qty</th> </tr> </thead> <tbody> <tr> <td>/</td> <td>$W \leq 0.03$</td> <td>Ignore</td> </tr> <tr> <td>$L \leq 2.5$</td> <td>$0.03 < W \leq 0.05$</td> <td>3</td> </tr> <tr> <td>$L \leq 2.5$</td> <td>$0.05 < W \leq 0.10$</td> <td>2</td> </tr> <tr> <td>/</td> <td>$0.1 < W$</td> <td>0</td> </tr> <tr> <td colspan="2">Total</td> <td>3</td> </tr> </tbody> </table> <p>Distance between 2 defects should more than 3mm apart. Scratches not viewable through the back of the display are acceptable.</p>	Length	Width	Acc. Qty	/	$W \leq 0.03$	Ignore	$L \leq 2.5$	$0.03 < W \leq 0.05$	3	$L \leq 2.5$	$0.05 < W \leq 0.10$	2	/	$0.1 < W$	0	Total		3
Length	Width	Acc. Qty																		
/	$W \leq 0.03$	Ignore																		
$L \leq 2.5$	$0.03 < W \leq 0.05$	3																		
$L \leq 2.5$	$0.05 < W \leq 0.10$	2																		
/	$0.1 < W$	0																		
Total		3																		
<p>04</p>	<p>Glass Crack (Minor defect)</p>	 <p>Crack is potential to enlarge, any type is not allowed.</p>																		
<p>05</p>	<p>Glass Chipping Pad Area: (Minor defect)</p> 	<table border="1" data-bbox="869 1612 1340 1787"> <thead> <tr> <th>Length and Width</th> <th>Acc. Qty</th> </tr> </thead> <tbody> <tr> <td>$c > 3.0, b < 1.0$</td> <td>1</td> </tr> <tr> <td>$c < 3.0, b < 1.0$</td> <td>3</td> </tr> <tr> <td colspan="2">$a < \text{Glass Thickness}$</td> </tr> </tbody> </table>	Length and Width	Acc. Qty	$c > 3.0, b < 1.0$	1	$c < 3.0, b < 1.0$	3	$a < \text{Glass Thickness}$											
Length and Width	Acc. Qty																			
$c > 3.0, b < 1.0$	1																			
$c < 3.0, b < 1.0$	3																			
$a < \text{Glass Thickness}$																				

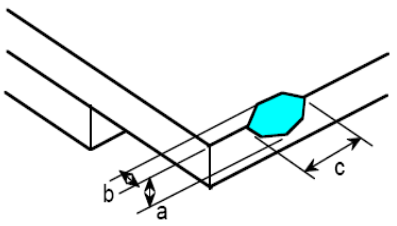
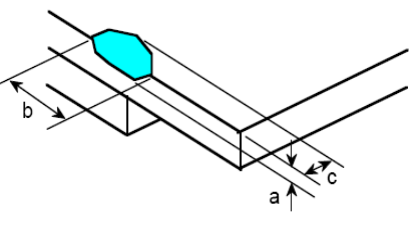
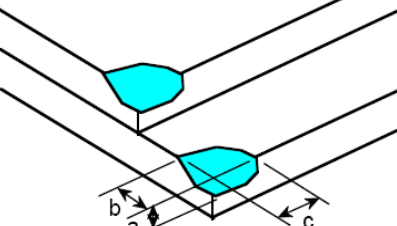
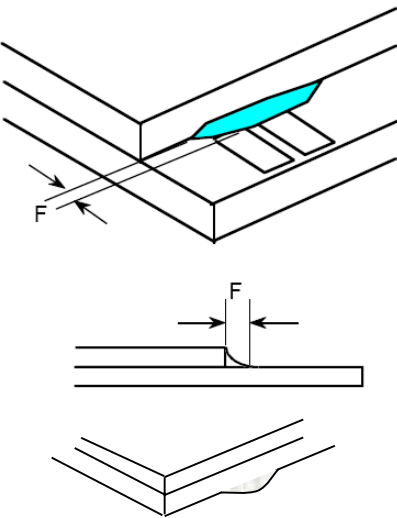
<p>06</p>	<p>Glass Chipping Rear of Pad Area: (Minor defect)</p> 	<table border="1"> <thead> <tr> <th>Length and Width</th> <th>Acc. Qty</th> </tr> </thead> <tbody> <tr> <td>$c > 3.0, b < 1.0$</td> <td>1</td> </tr> <tr> <td>$c < 3.0, b < 1.0$</td> <td>2</td> </tr> <tr> <td>$c < 3.0, b < 0.5$</td> <td>4</td> </tr> <tr> <td colspan="2">a < Glass Thickness</td> </tr> </tbody> </table>	Length and Width	Acc. Qty	$c > 3.0, b < 1.0$	1	$c < 3.0, b < 1.0$	2	$c < 3.0, b < 0.5$	4	a < Glass Thickness	
Length and Width	Acc. Qty											
$c > 3.0, b < 1.0$	1											
$c < 3.0, b < 1.0$	2											
$c < 3.0, b < 0.5$	4											
a < Glass Thickness												
<p>07</p>	<p>Glass Chipping Except Pad Area: (Minor defect)</p> 	<table border="1"> <thead> <tr> <th>Length and Width</th> <th>Acc. Qty</th> </tr> </thead> <tbody> <tr> <td>$c > 3.0, b < 1.0$</td> <td>1</td> </tr> <tr> <td>$c < 3.0, b < 1.0$</td> <td>2</td> </tr> <tr> <td>$c < 3.0, b < 0.5$</td> <td>4</td> </tr> <tr> <td colspan="2">a < Glass Thickness</td> </tr> </tbody> </table>	Length and Width	Acc. Qty	$c > 3.0, b < 1.0$	1	$c < 3.0, b < 1.0$	2	$c < 3.0, b < 0.5$	4	a < Glass Thickness	
Length and Width	Acc. Qty											
$c > 3.0, b < 1.0$	1											
$c < 3.0, b < 1.0$	2											
$c < 3.0, b < 0.5$	4											
a < Glass Thickness												
<p>08</p>	<p>Glass Corner Chipping: (Minor defect)</p> 	<table border="1"> <thead> <tr> <th>Length and Width</th> <th>Acc. Qty</th> </tr> </thead> <tbody> <tr> <td>$c < 3.0, b < 3.0$</td> <td>Ignore</td> </tr> <tr> <td colspan="2">a < Glass Thickness</td> </tr> </tbody> </table>	Length and Width	Acc. Qty	$c < 3.0, b < 3.0$	Ignore	a < Glass Thickness					
Length and Width	Acc. Qty											
$c < 3.0, b < 3.0$	Ignore											
a < Glass Thickness												
<p>09</p>	<p>Glass Burr: (Minor defect)</p> 	<table border="1"> <thead> <tr> <th>Length</th> <th>Acc. Qty</th> </tr> </thead> <tbody> <tr> <td>$F < 1.0$</td> <td>Ignore</td> </tr> </tbody> </table> <p>Glass burr don't affect assemble and module dimension.</p>	Length	Acc. Qty	$F < 1.0$	Ignore						
Length	Acc. Qty											
$F < 1.0$	Ignore											

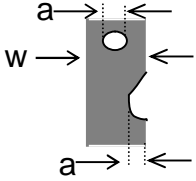
10	<p>FPC Defect: (Minor defect)</p> 	<p>10.1 Dent, pinhole width $a < w/3$. (w: circuitry width.) 10.2 Open circuit is unacceptable. 10.3 No oxidation, contamination and distortion.</p>										
11	Bubble on Polarizer (Minor defect)	<table border="1" data-bbox="743 551 1214 763"> <thead> <tr> <th>Diameter</th> <th>Acc. Qty</th> </tr> </thead> <tbody> <tr> <td>$\varphi \leq 0.20$</td> <td>Ignore</td> </tr> <tr> <td>$0.20 < \varphi \leq 0.30$</td> <td>4</td> </tr> <tr> <td>$0.30 < \varphi \leq 0.50$</td> <td>1</td> </tr> <tr> <td>$0.50 < \varphi$</td> <td>None</td> </tr> </tbody> </table>	Diameter	Acc. Qty	$\varphi \leq 0.20$	Ignore	$0.20 < \varphi \leq 0.30$	4	$0.30 < \varphi \leq 0.50$	1	$0.50 < \varphi$	None
Diameter	Acc. Qty											
$\varphi \leq 0.20$	Ignore											
$0.20 < \varphi \leq 0.30$	4											
$0.30 < \varphi \leq 0.50$	1											
$0.50 < \varphi$	None											
12	Dent on Polarizer (Minor defect)	<table border="1" data-bbox="743 824 1214 1037"> <thead> <tr> <th>Diameter</th> <th>Acc. Qty</th> </tr> </thead> <tbody> <tr> <td>$\varphi \leq 0.20$</td> <td>Ignore</td> </tr> <tr> <td>$0.20 < \varphi \leq 0.30$</td> <td>4</td> </tr> <tr> <td>$0.30 < \varphi \leq 0.50$</td> <td>1</td> </tr> <tr> <td>$0.50 < \varphi$</td> <td>None</td> </tr> </tbody> </table>	Diameter	Acc. Qty	$\varphi \leq 0.20$	Ignore	$0.20 < \varphi \leq 0.30$	4	$0.30 < \varphi \leq 0.50$	1	$0.50 < \varphi$	None
Diameter	Acc. Qty											
$\varphi \leq 0.20$	Ignore											
$0.20 < \varphi \leq 0.30$	4											
$0.30 < \varphi \leq 0.50$	1											
$0.50 < \varphi$	None											
13	Bezel	<p>13.1 No rust, distortion on the Bezel. 13.2 No visible fingerprints, stains or other contamination.</p>										
14	Touch Panel	<p>D: Diameter W: width L: length 14.1 Spot: $D < 0.25$ is acceptable $0.25 \leq D \leq 0.4$ 2dots are acceptable and the distance between defects should more than 10 mm. $D > 0.4$ is unacceptable 14.2 Dent: $D > 0.40$ is unacceptable 14.3 Scratch: $W \leq 0.03$, $L \leq 10$ is acceptable, $0.03 < W \leq 0.10$, $L \leq 10$ is acceptable Distance between 2 defects should more than 10 mm. $W > 0.10$ is unacceptable.</p>										
15	PCB	<p>15.1 No distortion or contamination on PCB terminals. 15.2 All components on PCB must same as documented on the BOM/component layout. 15.3 Follow IPC-A-600F.</p>										
16	Soldering	Follow IPC-A-610C standard										

17	Electrical Defect (Major defect)	The below defects must be rejected. 17.1 Missing vertical / horizontal segment, 17.2 Abnormal Display. 17.3 No function or no display. 17.4 Current exceeds product specifications. 17.5 LCD viewing angle defect. 17.6 No Backlight. 17.7 Dark Backlight. 17.8 Touch Panel no function.
----	-------------------------------------	------------------------------------------------------------------------------------------------------------------------------------------------------------------------------------------------------------------------------------------------------------------------------------------------------------------

Remark: LCD Panel Broken shall be rejected. Defect out of LCD viewing area is acceptable.

10.7. Classification of Defects

- 10.7.1. Visual defects (Except no / wrong label) are treated as minor defect and electrical defect is major.
- 10.7.2. Two minor defects are equal to one major in lot sampling inspection.

10.8. Identification/markings criteria

Any unit with illegible / wrong /double or no marking/ label shall be rejected.

10.9. Packing

- 10.9.1. There should be no damage of the outside carton box, each packaging box should have one identical label.
- 10.9.2. Modules inside package box should have compliant mark.
- 10.9.3. All direct package materials shall offer ESD protection.

Note1: Bright dot is defined as the defective area of the dot is larger than 50% of one sub-pixel area.

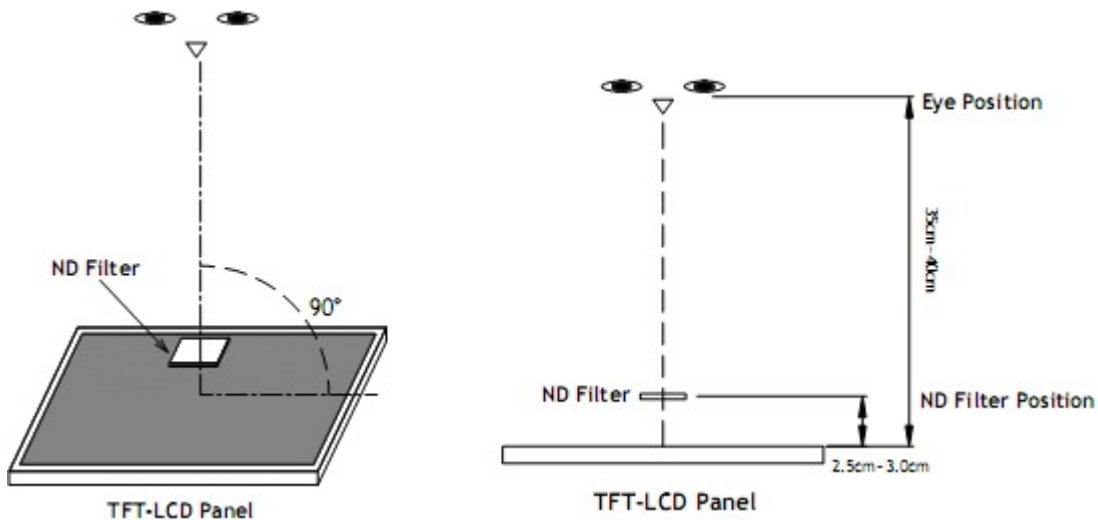

Bright dot: The bright dot size defect at black display pattern. It can be recognized by 2% transparency of filter when the distance between eyes and panel is 350mm ± 50mm.

Dark dot: Cyan, Magenta or Yellow dot size defect at white display pattern. It can be recognized by 5% transparency of filter when the distance between eyes and panel is 350mm ± 50mm.

Note2: Mura on display which appears darker / brighter against background brightness on parts of display area

11. Reliability Specification

No	Item	Condition	Quantity	Criteria
1	High Temperature Operating	70°C, 96Hrs	2	GB/T2423.2-2008
2	Low Temperature Operating	-20°C, 96Hrs	2	GB/T2423.1-2008
3	High Humidity	50°C, 90%RH, 96Hrs	2	GB/T2423.3-2006
4	High Temperature Storage	80°C, 96Hrs	2	GB/T2423.2-2008
5	Low Temperature Storage	-30°C, 96Hrs	2	GB/T2423.1-2008
6	Thermal Cycling Test	-20°C, 60min~70°C, 60min, 20 cycles.	2	GB/T2423.22-2012
7	Packing Vibration	Frequency range:10Hz~50Hz Acceleration of gravity:5G X, Y, Z 30 min for each direction.	2	GB/T5170.14-2009
8	Electrical Static Discharge	Air: ± 4kV 150pF/330 Ω 5 times	2	GB/T17626.2-2006
		Contact: ± 2kV 150pF/330 Ω 5 times		
9	Drop Test (Packaged)	Height:80 cm,1 corner, 3 edges, 6 surfaces.	2	GB/T2423.8-1995

Note1. No deflection cosmetic and operational function allowable.

Note2. Total current Consumption should be below double of initial value

12. Precautions and Warranty

12.1. Safety

- 12.1.1. The liquid crystal in the LCD is poisonous. Do not put it in your mouth. If the liquid crystal touches your skin or clothes, wash it off immediately using soap and water.
- 12.1.2. Since the liquid crystal cells are made of glass, do not apply strong impact on them. Handle with care.

12.2. Handling

- 12.2.1. Reverse and use within ratings in order to keep performance and prevent damage.
- 12.2.2. Do not wipe the polarizer with dry cloth, as it might cause scratch. If the surface of the LCD needs to be cleaned, wipe it swiftly with cotton or other soft cloth soaked with petroleum IPA, do not use other chemicals.

12.3. Storage

- 12.3.1. Do not store the LCD module beyond the specified temperature ranges.
- 12.3.2. Strong light exposure causes degradation of polarizer and color filter.

12.4. Metal Pin (Apply to Products with Metal Pins)

12.4.1. Pins of LCD and Backlight

12.4.1.1. Solder tip can touch and press on the tip of Pin LEAD during the soldering

12.4.1.2. Recommended Soldering Conditions

Solder Type: Sn96.3~94-Ag3.3~4.3-Cu0.4~1.1

Maximum Solder Temperature: 370°C

Maximum Solder Time: 3s at the maximum temperature

Recommended Soldering Temp: 350±20°C

Typical Soldering Time: ≤3s

12.4.1.3. Solder Wetting

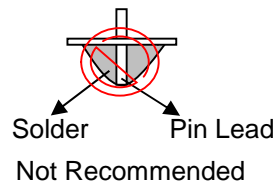
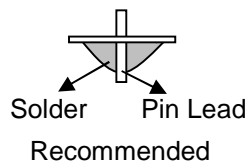

12.4.2. Pins of EL

12.4.2.1. Solder tip can touch and press on the tip of EL leads during soldering.

12.4.2.2. No Solder Paste on the soldering pad on the motherboard is recommended.

12.4.2.3. Recommended Soldering Conditions

Solder type: Nippon Alimit Leadfree SR-34, size 0.5mm

Recommended Solder Temperature: 270~290°C

Typical Soldering Time: ≤2s

Minimum solder distance from EL lamp (body):2.0mm

12.4.2.4. No horizontal press on the EL leads during soldering.

12.4.2.5. 180° bend EL leads three times is not allowed.

12.4.2.6. Solder Wetting

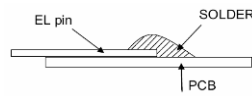

Recommended

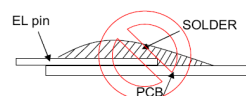

Not Recommended

12.4.2.7. The type of the solder iron:

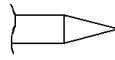

Recommended

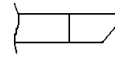

Not Recommended

12.4.2.8. Solder Pad

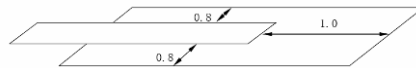

12.5.Operation

- 12.5.1. Do not drive LCD with DC voltage
- 12.5.2. Response time will increase below lower temperature
- 12.5.3. Display may change color with different temperature
- 12.5.4. Mechanical disturbance during operation, such as pressing on the display area, may cause the segments to appear “fractured”.
- 12.5.5. Do not connect or disconnect the LCM to or from the system when power is on.
- 12.5.6. Never use the LCM under abnormal condition of high temperature and high humidity.
- 12.5.7. Module has high frequency circuits. Sufficient suppression to the electromagnetic interface shall be done by system manufacturers. Grounding and shielding methods may be important to minimize the interference.
- 12.5.8. Do not display the fixed pattern for long time (we suggest the time not longer than one hour) because it may develop image sticking due to the TFT structure.

12.6.Static Electricity

- 12.6.1. CMOS LSIs are equipped in this unit, so care must be taken to avoid the electro-static charge, by ground human body, etc.
- 12.6.2. The normal static prevention measures should be observed for work clothes and benches.
- 12.6.3. The module should be kept into anti-static bags or other containers resistant to static for storage.

12.7.Limited Warranty

- 12.7.1. Our warranty liability is limited to repair and/or replacement. We will not be responsible for any consequential loss.
- 12.7.2. If possible, we suggest customer to use up all modules in six months. If the module storage time over twelve months, we suggest that recheck it before the module be used.
- 12.7.3. After the product shipped, any product quality issues must be feedback within three months, otherwise, we will not be responsible for the subsequent or consequential events.

13. Outline Drawing

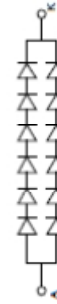
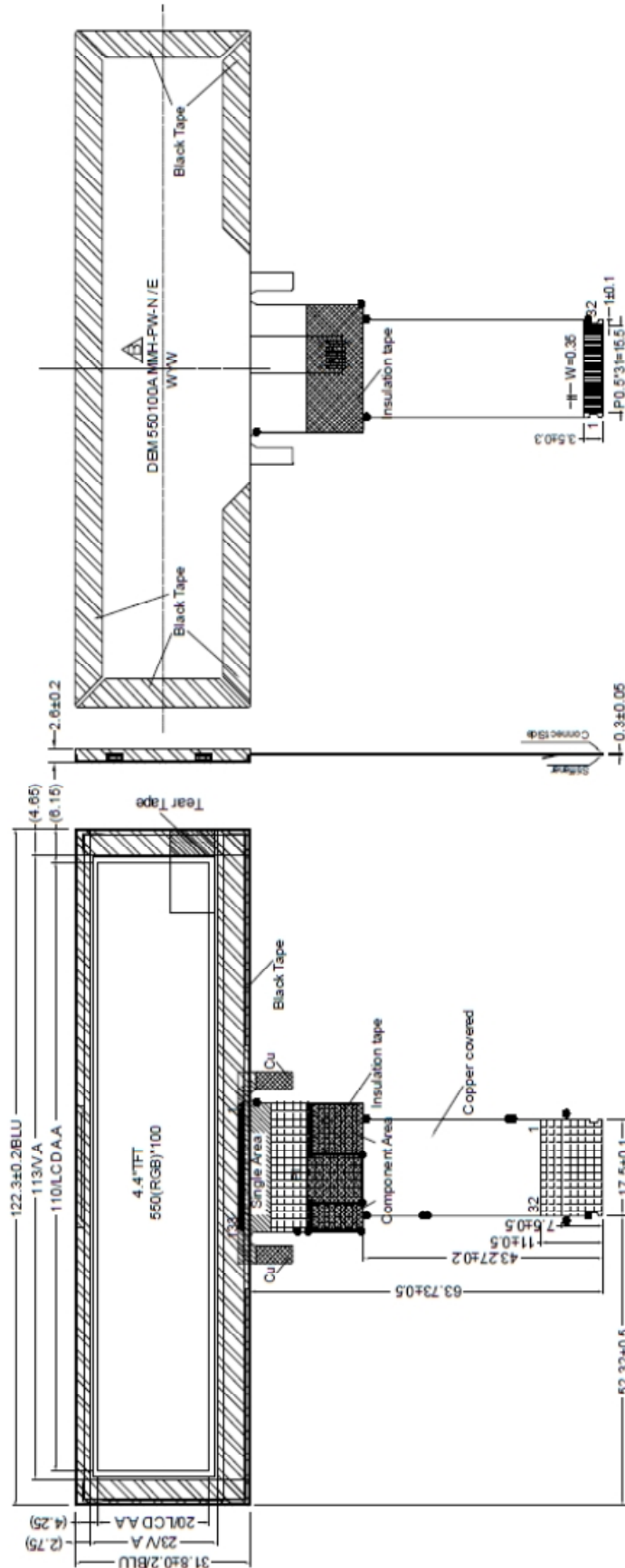

Circuit Diagram

Pin assignment	Pin assignment	Pin assignment	Pin assignment	Pin assignment	Pin assignment
PIN SYMBOL	PIN SYMBOL	PIN SYMBOL	PIN SYMBOL	PIN SYMBOL	PIN SYMBOL
1 GND	9 GND	17 DB3	25 LED-A		
2 VCC	10 RD	18 GND	26 LED-A		
3 VCC	11 WR	19 DB4	27 LED-K		
4 GND	12 GND	20 DB5	28 LED-K		
5 CS	13 DB0	21 GND	29 LED-K		
6 TE	14 DB1	22 DB6	30 LED-K		
7 RESET	15 GND	23 DB7	31 ESD-GND		
8 RS	16 DB2	24 GND	32 ESD-GND		

- NOTES:
1. Display size: 4.4" TFT
 2. Viewing direction: Full Viewing
 3. Display mode: Transmissive/Normal Black/Anti-Glare
 4. Operation temperature: -20 °C ~ +70 °C
 5. Storage temperature: -30 °C ~ +80 °C
 6. Power supply voltage: 3.3V
 7. Driver IC: ST7511
 8. Backlight : White (12 LED); Vf=19.2(TYP)/40mA
 9. Brightness: 300cd/m² (TYP)
LED Life Time: 20Khrs(Min)~30Khrs(Typ)
 10. ROHS must be complied
- * Unspecification tolerance are ±0.2mm