

Display Elektronik GmbH

DATA SHEET

LCD MODULE

**DEM 320240F TMH-PW-N
(A-TOUCH)**

3,5" TFT with Touch-Panel

Product Specification

Ver.: 9

07.02.2012

Revise Records

Rev.	Date	Contents	Written	Approved
1	01.08.2007	Preliminary Specification	KL	GC
2	31.01.2008	Modify Color Chromaticity	KC	JL
3	20.05.2008	Revise the wrongly written character and Viewing Angle	KC	KL
4	16.09.2008	Remove Appearance 12.3	KS	DL
5	09.11.2010	1. Modify LCM Drawing 2. Add ROHS Compliance 3. Remove Appearance 12,14,15	KS	SC
6	06.12.2010	Add life time of backlight.	KC	SC
7	24.12.2010	1. Corrected Electrical Characteristics(9.1) 2. Corrected Dimensional Outlines(page6)	KC	SC
8	20.01.2011	Add IIS	KC	SC
9	07.02.2012	Add typical value of LED lifetime.	KC	SC

Special Notes

Note1.	
Note2.	
Note3.	
Note4.	
Note5.	

Contents

1. General Description and Features	4
1.1 Features	4
1.2 Applications	4
1.3 LCD Module	4
2. Mechanical Information	4
3. Dimensional Outlines	5
4. Block Diagram	6
4.1 TFT-LCD Module with BLU & TSP	6
5. Input Terminal Pin Assignment	7
5.1 Pin Assignment (LCD)	7
6. Optical Characteristics	9
7. Touch Screen Panel Specifications	11
7.1 Touch Panel	11
8. Absolute Maximum Ratings	12
8.1 Absolute Ratings of Environment	12
8.2 Electrical Absolute Rating	12
9. Electrical Characteristics	13
9.1 TFT-LCD Module (DC Characteristics)	13
9.2 Backlight Unit	13
10. Basic Display Color and Gray Scale	14
11. AC Timing	15
11.1 AC Characteristics (Pixel Timing)	15
11.2 SPI Timing Characteristics	16
11.3 Write SPI interface Timing Diagram	16
11.4 Read SPI interface Timing Diagram	17
11.5 AC Characteristics	17
11.6 Timing in Parallel RGB (24 bit SYNC Mode)	18
11.7 Timing in Parallel RGB (24 bit DE Mode)	18
12. Reliability Condition for LCD	19
13. Incoming Inspection Standards	20

1. General Description and Features

DEM 320240F TMH-PW-N(A-TOUCH) is a TM (Transmissive) type color active matrix TFT (Thin Film Transistor) liquid crystal display (LCD) that uses amorphous silicon TFT as a switching device. This model is composed of a TFT-LCD module, a driver circuit, a back-light unit and a touch screen panel (TSP). The resolution of a 3.5" contains 320RGBx240 dots and can display up to 16.7M colors. The following table described the features of DEM 320240F TMH-PW-N(A-TOUCH).

1.1 Features

- Transmissive and backlight with six LEDs are available.
- TN (Twisted Nematic) mode.
- Programmable Frame & N-line polarity inversion.
- Using the Touch Screen Panel (Film to Glass type).
- System & Graphic interface 3-lines SPI + 8bits color RGB.
- Data Enable Input Mode, SYNC Mode
- ROHS Compliance

1.2 Applications

- Display terminals for DSC (Digital Still Camera), PMP (Portable Multimedia Player) application products.

1.3 LCD Module

Item	Specification	Unit
Screen Size	3.5 inches	Diagonal
Display Resolution	320 x RGB x 240	Dot
Dot Pitch	0.219 (H) x 0.219 (V)	mm
Active Area	70.08 (H) x 52.56 (V)	mm
Outline Dimension	76.9 (W) x 63.9 (H) x 4.4 (D)	mm
Display Mode	Normally white/Transmissive	--
Pixel Arrangement	RGB-Stripe	--
Surface Treatment	Anti-glare (AG)	--
Display Color	16.7M	--
Viewing Direction	6 o'clock	--
Input Interface	Digital 8-bits color RGB	--
Color Gamut	NTSC 60%	--

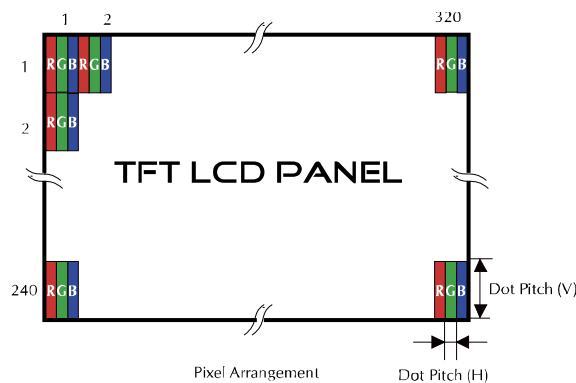

2. Mechanical Information

Item	Min.	Typ.	Max.	Unit	Note
Module Size	Horizontal (H)	--	76.90	mm	--
	Vertical (V)	--	63.90	mm	(1)
	Thickness (T)	--	4.40	mm	(2)
Weight	--	(45)	--	g	--

Note (1) Not include FPC.

Refer to the Outline Dimension for further information.

(2) Back-light & touch screen unit are included.

3. Dimensional Outlines

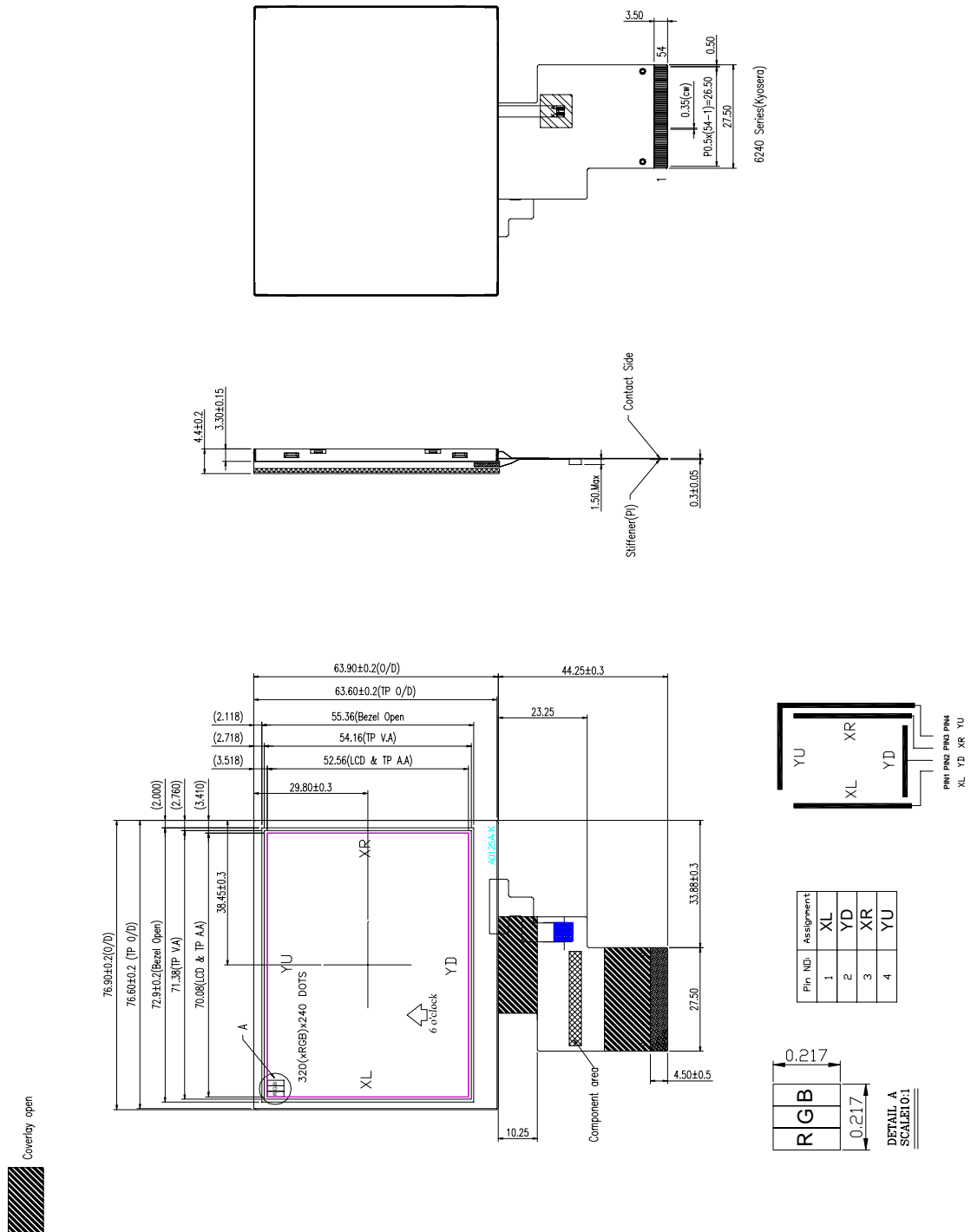

PIN ASSIGNMENT	
1.	LED-
2.	LED-
3.	LED+
4.	LED+
5.	NC
6.	NC
7.	/RESET
8.	/CS
9.	CLK
10.	SDB
11.	SDO
12.	BO
13.	B1
14.	B2
15.	B3
16.	B4
17.	B5
18.	B6
19.	B7
20.	GO
21.	G1
22.	G2
23.	G3
24.	G4
25.	G5
26.	G6
27.	G7
28.	RO
29.	R1
30.	R2
31.	R3
32.	R4
33.	R5
34.	R6
35.	R7
36.	HSYNC
37.	VSYNC
38.	DCLK
39.	VDDIO
40.	VDDIO
41.	VCI
42.	VCI
43.	REGVDD
44.	NC
45.	YU/TP
46.	XR/RIGHT
47.	YD/BOTTOM
48.	XL/LEFT
49.	NC
50.	NC
51.	NC
52.	DE
53.	GND
54.	GND

4. Block Diagram

4.1 TFT-LCD Module with BLU & TSP

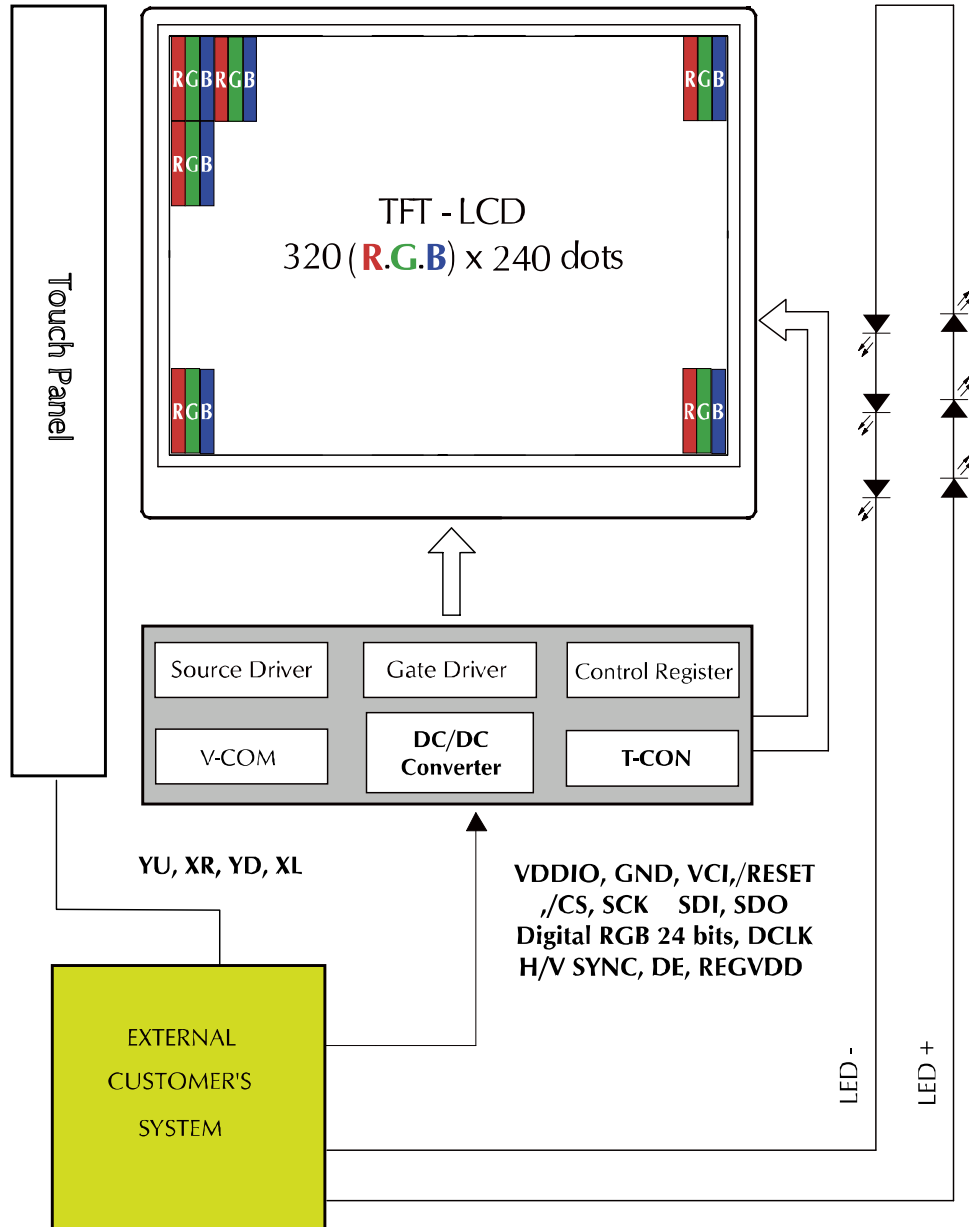

5. Input Terminal Pin Assignment

5.1 Pin Assignment (LCD)

Pin No.	Symbol	I/O	Function	Remark
1	LED-	I	Backlight LED Ground	
2	LED-	I	Backlight LED Ground	
3	LED+	I	Backlight LED Power	
4	LED+	I	Backlight LED Power	
5	N/C	---	Not Connection	
6	N/C	--	Not Connection	
7	/RESET	I	Hardware Reset	
8	/CS	I	Serial Interfaces, Chip Select pin	
9	SCLK	I	SPI Interface Clock pin	
10	SDI	I	SPI Interface Data output pin	
11	SDO	O	SPI Interface Data output pin	
12	B0	I	Blue Data Bit 0	
13	B1	I	Blue Data Bit 1	
14	B2	I	Blue Data Bit 2	
15	B3	I	Blue Data Bit 3	
16	B4	I	Blue Data Bit 4	
17	B5	I	Blue Data Bit 5	
18	B6	I	Blue Data Bit 6	
19	B7	I	Blue Data Bit 7	
20	G0	I	Green Data Bit0	
21	G1	I	Green Data Bit1	
22	G2	I	Green Data Bit2	
23	G3	I	Green Data Bit3	
24	G4	I	Green Data Bit4	
25	G5	I	Green Data Bit5	
26	G6	I	Green Data Bit6	
27	G7	I	Green Data Bit7	
28	R0	I	Red Data Bit0	
29	R1	I	Red Data Bit1	
30	R2	I	Red Data Bit2	
31	R3	I	Red Data Bit3	
32	R4	I	Red Data Bit4	
33	R5	I	Red Data Bit5	
34	R6	I	Red Data Bit6	
35	R7	I	Red Data Bit7	
36	H _{SYNC}	I	Horizontal Sync Input	
37	V _{SYNC}	I	Vertical Sync Input	
38	D _{CLK}	I	Dot Data Clock	
39	V _{DDIO}	P	Voltage input pin for I/O logic. - Connect to system Vdd	

40	V _{DDIO}	P	Voltage input pin for I/O logic. - Connect to system Vdd	
41	V _{CI}	P	Booster input voltage pin. - Connect to voltage source between 2.5V to 3.6V	
42	V _{CI}	P	Positive Power Supply for Interfaces and Control lines	
43	REGVDD	I	Input pin to enable internal voltage regulation. -Connect to VDDIO if System Vdd > 2.5V -Connect to GND if 2.5V ³ System Vdd ³ 1.8V, internal regulator will be disabled	
44	N/C	--	Not Connection	
45	YU	I	Touch Panel Top Side	
46	XR	I	Touch Panel Right Side	
47	YD	I	Touch Panel Bottom Side	
48	XL	I	Touch Panel Left Side	
49	N/C	--	Not Connection	
50	N/C	--	Not Connection	
51	N/C	--	Not Connection	
52	DE	I	Data Enable Input	
53	GND	P	Ground	
54	GND	P	Ground	

6. Optical Characteristics

The following items are measured under stable conditions. The optical characteristics should be measured in a dark room or equivalent state.

Measuring equipment: BM-5A, BM-7A,

(Ta=25±2°C , VDDIO = VCl=2.8V, If=20mA)

Item	Symbol	Condition	Min	Type	Max	Unit	Note
Brightness	--		(200)	(250)	--	cd/m ²	--
Response time	T _R	θ=0°	--	15	20	ms	Note.
	T _F		--	35	50	ms	
Contrast ratio	CR	At optimized viewing angle	240	300	--	--	Note.
Color Chromaticity (CIE1931)	Red	R _X	(0.590)	(0.640)	(0.690)	--	Note.
		R _Y	(0.294)	(0.344)	(0.394)		
	Green	G _X	(0.248)	(0.298)	(0.348)	--	
		G _Y	(0.532)	(0.583)	(0.633)		
	Blue	B _X	(0.090)	(0.140)	(0.190)	--	
		B _Y	(0.080)	(0.130)	(0.180)		
	White	W _X	(0.262)	(0.312)	(0.362)	--	
		W _Y	(0.299)	(0.349)	(0.399)		
Viewing Angle (6H)	Hor.	θ _R	50	60	--	Degree	Note.
		θ _L	50	60	--		
	Ver.	φ _H	40	50	--		
		φ _L	50	60	--		

Note : Definition of Transmittance (T%)

$$T = \text{Aperture Ratio (TFT)} \times W_Y \text{ (CF)}$$

a. Test equipment setup

After stabilizing and leaving the panel alone shall be warmed up for the stable operation of LCM, the measurement should be executed. Measurement should be executed in a stable, windless, and dark room. Optical specifications are measured by Topcon BM-7(fast) with a viewing angle of 2° at a distance of 50cm and normal direction.

b. Definition of response time: Tr and Tf

The response time is defined as the following figure and shall be measured by switching the input signal for "black" and "white".

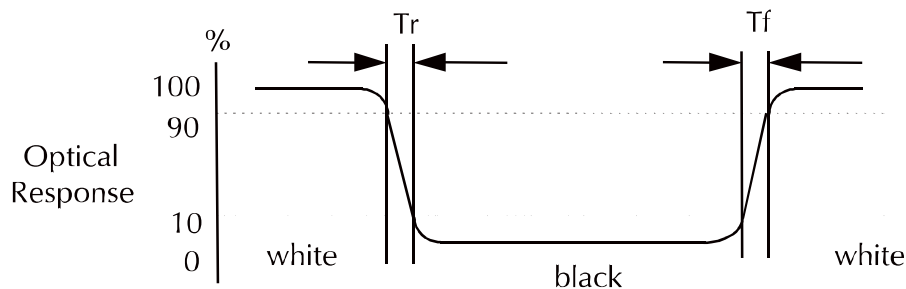

c. Definition of contrast ratio:

Brightness measured when LCD is at "white state"

$$\text{Contrast Ratio (CR)} = \frac{\text{Brightness measured when LCD is at "white state"}}{\text{Brightness measured when LCD is at "black state"}}$$

Brightness measured when LCD is at "black state"

d. Measured at the center area of the panel when all the input terminals of LCD panel are electrically opened.

e. View Angle

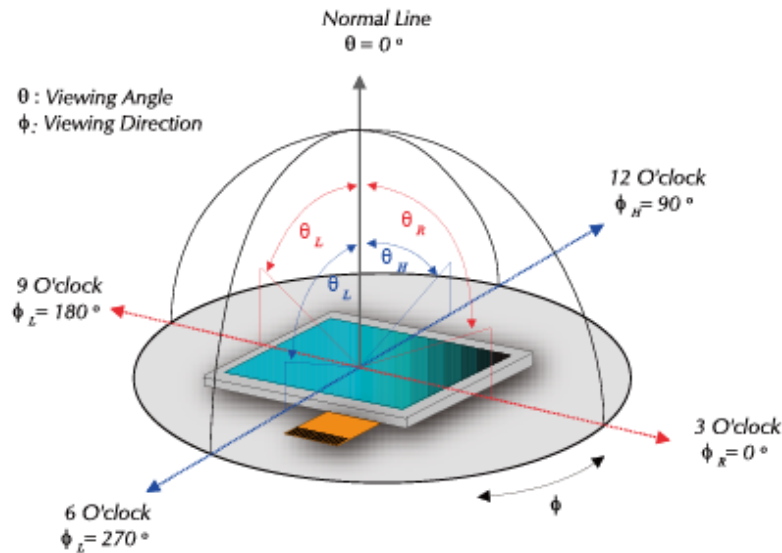

f. Definition of Luminance of White: Luminance of white at the center points

Light Source of Back-Light Unit	LED Type
---------------------------------	----------

g. Definition of White Uniformity

$$\text{White Uniformity} = \frac{\text{Min. luminance of white among 9-points}}{\text{Max. luminance of white among 9-points}}$$

h. The definition of Color Gamut -Color Chromaticity CIE 1931

Color coordinate of white & red, green, blue at center point.

$$\text{Color Gamut : NTSC(\%)} = (\text{RGB Triangle Area} / \text{NTSC Triangle Area}) \times 100$$

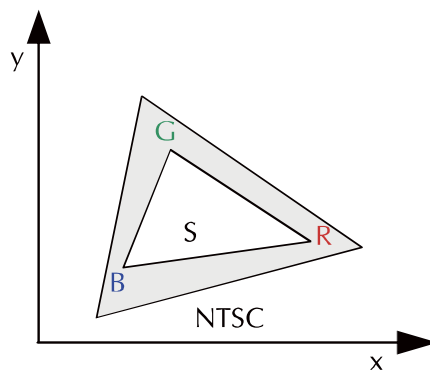

7. Touch Screen Panel Specifications

7.1 Touch Panel

7.1.1 Electrical Characteristics

Item	Min.	Typ.	Max.	Unit	Note
Linearity	-1.5	-	1.5	%	Analog X and Y directions
Terminal resistance	200	-	700	Ω	X(Glass side)
	200	-	900	Ω	Y(Film side)
Insulation resistance	20	-	-	MΩ	DC 25V
Voltage	-	5.0	7.0	V	DC
Chattering	-	-	10	ms	100kΩ pull-up
Transparency	-	82	-	%	Non-glare

Caution (1) : Do not operate it with a thing except a polyacetal pen (tip R0.8mm or less) or a finger, especially those with hard or sharp tips such as a ball point pen or a mechanical pencil.

7.1.2 Mechanical & Reliability Characteristics

Item	Min.	Typ.	Max.	Unit	Note
Activation force	-		80	g	(1)
Durability-surface scratching	Write 100,000	-	-	characters	(2)
Durability-surface pitting	1,000,000	-	-	touches	(3)
Surface hardness	3	-	-	H	JIS K5400,ASTM D3363

Note (1) Stylus pen Input : R0.8mm polyacetal pen or Finger

Note (2) Measurement for Surface area - Scratch 100,000 times straight line on the Film with a stylus change every 20,000times

- Force : 150gf
- Speed : 100mm/sec
- Stylus : R0.8 polyacetal tip

Note (2) Pit 1,000,000 times on the Film with a R8.0 silicon rubber.

- Force : Force : 250gf
- Speed : 3times/sec

8. Absolute Maximum Ratings

8.1 Absolute Ratings of Environment

If the operating condition exceeds the following absolute maximum ratings, the TFT LCD module may be damaged permanently.

(Ta=25±2°C, V_{SS}=GND=0)

Item	Symbol	Min.	Max.	Unit	Note
Storage temperature	T _{STG}	-20	70	°C	(1)
Operating temperature (Ambient temperature)	T _{OPR}	-10	60	°C	(1), (2)

Note (1) 95 % RH Max. (40 °C ≥ Ta)

Maximum wet-bulb temperature at 39 °C or less. (Ta > 40 °C) No condensation.

Note (2) In case of below 0°, the response time of liquid crystal (LC) becomes slower and the color of panel becomes darker than normal one. Level of retardation depends on temperature, because of LC's character.

8.2 Electrical Absolute Rating

8.2.1 TFT-LCD Module

(Voltage Referenced to VSS)

Item	Symbol	Value		Unit	Condition
		Min.	Max.		
Supply Voltage	VDD	-0.3	+2.7	V	--
	VDDIO	-0.3	+4.0	V	--
Input Voltage	VCI	VSS-0.3	5.0	V	--
Current Drain Per Pin Excluding VDD and VSS	I	--	25	mA	--

8.2.2 Backlight Unit

(Ta=25±2°C)

Item	Symbol	Min.	Max.	Unit	Note
Current	I _f	--	30	mA	(1)

Note (1) Permanent damage to the device may occur if maximum values are exceeded or reverse voltage is loaded. Functional operation should be restricted to the conditions described under normal operating conditions.

9. Electrical Characteristics

9.1 TFT-LCD Module (DC Characteristics)

(TA=25°C)

Item	Symbol	Condition	Value			Unit
			Min.	Typ.	Max.	
Logic Power Supply	V _{DDIO}		2.5	3.3	3.6	V
Boost Power Supply	V _{Cl}		2.5	3.3	3.6	V
Logic High Input voltage	V _{IH}		0.8 V _{DDIO}	-	V _{DDIO}	V
Logic Low Input voltage	V _{IL}		0	-	0.2 V _{DDIO}	
Logic Power current	I _{VDDIO}	V _{DDIO} =3.3V	-	0.5	-	mA
Boost Power current	I _{VCl}		-	7	-	mA

9.2 Backlight Unit

The back-light system is an edge-lighting type with six white LEDs (Light Emitting Diode).

(Ta=25±2°C)

Item	Symbol	Value			Unit	Condition
		Min.	Typ.	Max.		
Power Consumption	P _{LED}	-	408	-	mW	(2)
Forward voltage	V _f	-	(19.8)	-		(1)
LED Current	I _f	-	20	-	mA	
LED Life Time(25°C)	-	(20000)	(30000)	-	hr	(3)

Note (1) Six LEDs serial type.

(2) Where I_f = 20mA, V_f = P_{LED} / I_f

(3) The environmental conducted under ambient air flow ,at Ta=25±2°C,60%RH±5%

10. Basic Display Color and Gray Scale

	Color & Gray Scale	Data Signal																							
		R7	R6	R5	R4	R3	R2	R1	R0	G7	G6	G5	G4	G3	G2	G1	G0	B7	B6	B5	B4	B3	B2	B1	B0
Basic Color	Black	0	0	0	0	0	0	0	0	0	0	0	0	0	0	0	0	0	0	0	0	0	0	0	
	Red	1	1	1	1	1	1	1	1	0	0	0	0	0	0	0	0	0	0	0	0	0	0	0	
	Green	0	0	0	0	0	0	0	0	1	1	1	1	1	1	1	1	0	0	0	0	0	0	0	
	Blue	0	0	0	0	0	0	0	0	0	0	0	0	0	0	0	0	1	1	1	1	1	1	1	
	Cyan	0	0	0	0	0	0	0	0	1	1	1	1	1	1	1	1	1	1	1	1	1	1	1	
	Magenta	1	1	1	1	1	1	1	1	0	0	0	0	0	0	0	0	1	1	1	1	1	1	1	
	Yellow	1	1	1	1	1	1	1	1	1	1	1	1	1	1	1	1	0	0	0	0	0	0	0	
	White	1	1	1	1	1	1	1	1	1	1	1	1	1	1	1	1	1	1	1	1	1	1	1	
Red	Black	0	0	0	0	0	0	0	0	0	0	0	0	0	0	0	0	0	0	0	0	0	0		
	Red(1)	0	0	0	0	0	0	0	1	0	0	0	0	0	0	0	0	0	0	0	0	0	0		
	Red(2)	0	0	0	0	0	0	1	0	0	0	0	0	0	0	0	0	0	0	0	0	0	0		
	:	:	:	:	:	:	:	:	:	:	:	:	:	:	:	:	:	:	:	:	:	:	:		
	Red(127)	0	1	1	1	1	1	1	1	0	0	0	0	0	0	0	0	0	0	0	0	0	0		
	:	:	:	:	:	:	:	:	:	:	:	:	:	:	:	:	:	:	:	:	:	:	:		
	Red(254)	1	1	1	1	1	1	1	0	0	0	0	0	0	0	0	0	0	0	0	0	0	0		
	Red(255)	1	1	1	1	1	1	1	1	0	0	0	0	0	0	0	0	0	0	0	0	0	0		
Green	Black	0	0	0	0	0	0	0	0	0	0	0	0	0	0	0	0	0	0	0	0	0	0		
	Green(1)	0	0	0	0	0	0	0	0	0	0	0	0	0	0	1	0	0	0	0	0	0	0		
	Green(2)	0	0	0	0	0	0	0	0	0	0	0	0	0	1	0	0	0	0	0	0	0	0		
	:	:	:	:	:	:	:	:	:	:	:	:	:	:	:	:	:	:	:	:	:	:	:		
	Green(127)	0	0	0	0	0	0	0	0	0	1	1	1	1	1	1	1	0	0	0	0	0	0		
	:	:	:	:	:	:	:	:	:	:	:	:	:	:	:	:	:	:	:	:	:	:	:		
	Green(254)	0	0	0	0	0	0	0	0	1	1	1	1	1	1	1	0	0	0	0	0	0	0		
	Green(255)	0	0	0	0	0	0	0	0	1	1	1	1	1	1	1	0	0	0	0	0	0	0		
Blue	Black	0	0	0	0	0	0	0	0	0	0	0	0	0	0	0	0	0	0	0	0	0	0		
	Blue(1)	0	0	0	0	0	0	0	0	0	0	0	0	0	0	0	0	0	0	0	0	0	1		
	Blue(2)	0	0	0	0	0	0	0	0	0	0	0	0	0	0	0	0	0	0	0	0	0	1		
	:	:	:	:	:	:	:	:	:	:	:	:	:	:	:	:	:	:	:	:	:	:	:		
	Blue(127)	0	0	0	0	0	0	0	0	0	0	0	0	0	0	0	0	1	1	1	1	1	1		
	:	:	:	:	:	:	:	:	:	:	:	:	:	:	:	:	:	:	:	:	:	:	:		
	Blue(254)	0	0	0	0	0	0	0	0	0	0	0	0	0	0	0	1	1	1	1	1	1	0		
	Blue(255)	0	0	0	0	0	0	0	0	0	0	0	0	0	0	0	1	1	1	1	1	1	1		

0 : Low level voltage, 1 :High level voltage

Each basic color can be displayed in 256 gray scales from 8 bit data signals. With the combination of total 24 bit data signals, the 16,777,216-color display can be achieved on the screen.

11. AC Timing

11.1 AC Characteristics (Pixel Timing)

(Unless otherwise specified, Voltage Referenced to VSS, VDDIO = 2.8V, TA = 25°C)

Item	Symbol	Min.	Typ.	Max.	Unit
DOTCLK Frequency	fDOTCLK	-	6.5	10	MHz
DOTCLK Period	tDOTCLK	100	154	-	ns
Vertical Sync Setup Time	tvsys	20	-	-	ns
Vertical Sync Hold Time	tvsyh	20	-	-	ns
Horizontal Sync Setup Time	thsys	20	-	-	ns
Horizontal Sync Hold Time	thsyh	20	-	-	ns
Phase difference of Sync Signal Falling Edge	thv	1	-	240	tDOTCLK
DOTCLK Low Period	tCKL	50	-	-	ns
DOTCLK High Period	tCKH	50	-	-	ns
Data Setup Time	tds	12	-	-	ns
Data hold Time	tdh	12	-	-	ns
Reset pulse width	tRES	10	-	-	us

Note: External clock source must be provided to DOTCLK pin of HX8238-A. The driver will not operate if absent of the clocking signal.

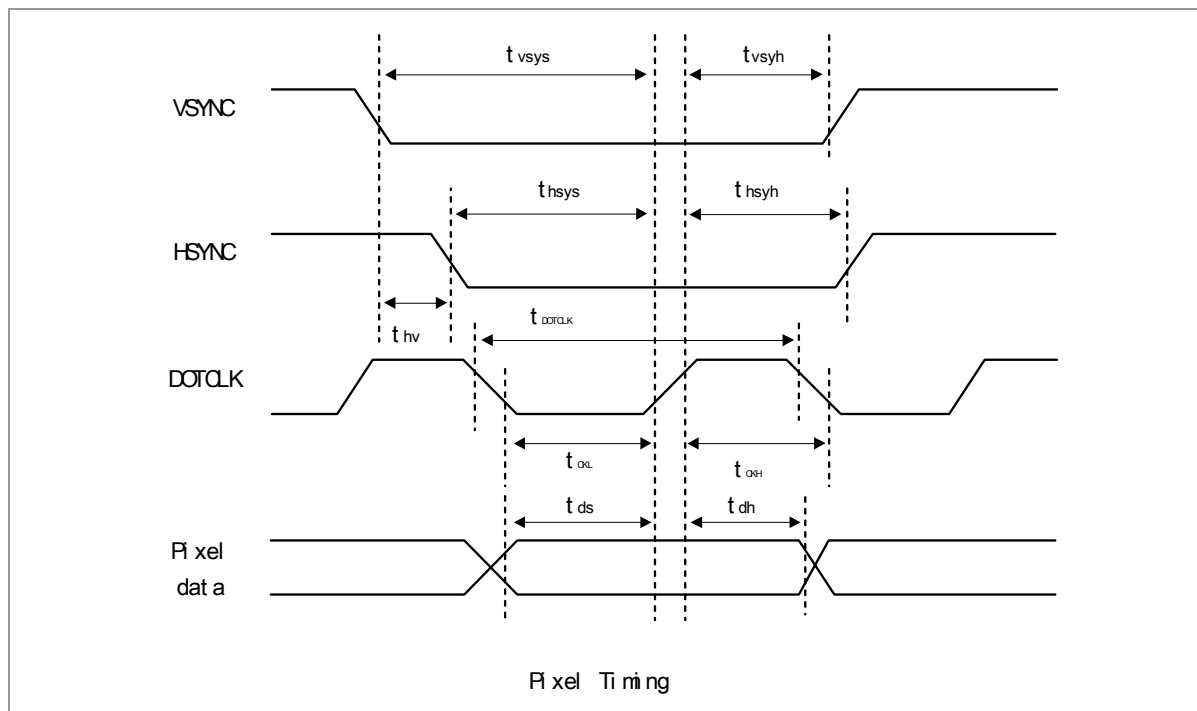

11.2 SPI Timing Characteristics

Item	Symbol	Min.	Typ.	Max.	Unit
Serial Clock Frequency	fclk	-	-	20	MHz
Serial Clock Cycle Time	tclk	50	-	-	ns
Clock Low Width	tsl	25	-	-	ns
Clock High Width	tsh	25	-	-	ns
Chip Select Setup Time	tcss	0	-	-	ns
Chip Select Hold Time	tcsH	10	-	-	ns
Chip Select High Delay Time	tcsd	20	-	-	ns
Data Setup Time	tds	5	-	-	ns
Data Hold Time	tdh	10	-	-	ns

11.3 Write SPI interface Timing Diagram

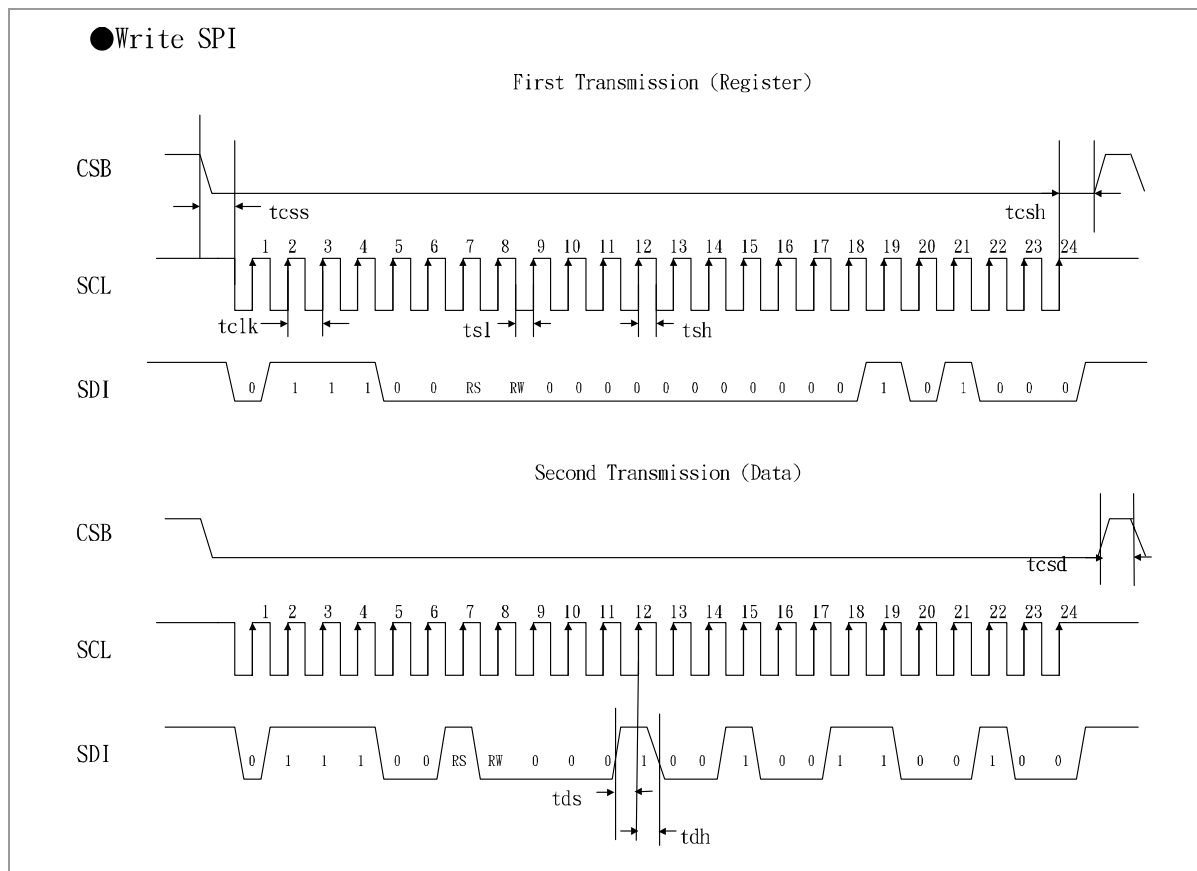

Note: The example writes "0x1264h" to register R28h.
 SPID connected to VSS.

11.4 Read SPI interface Timing Diagram

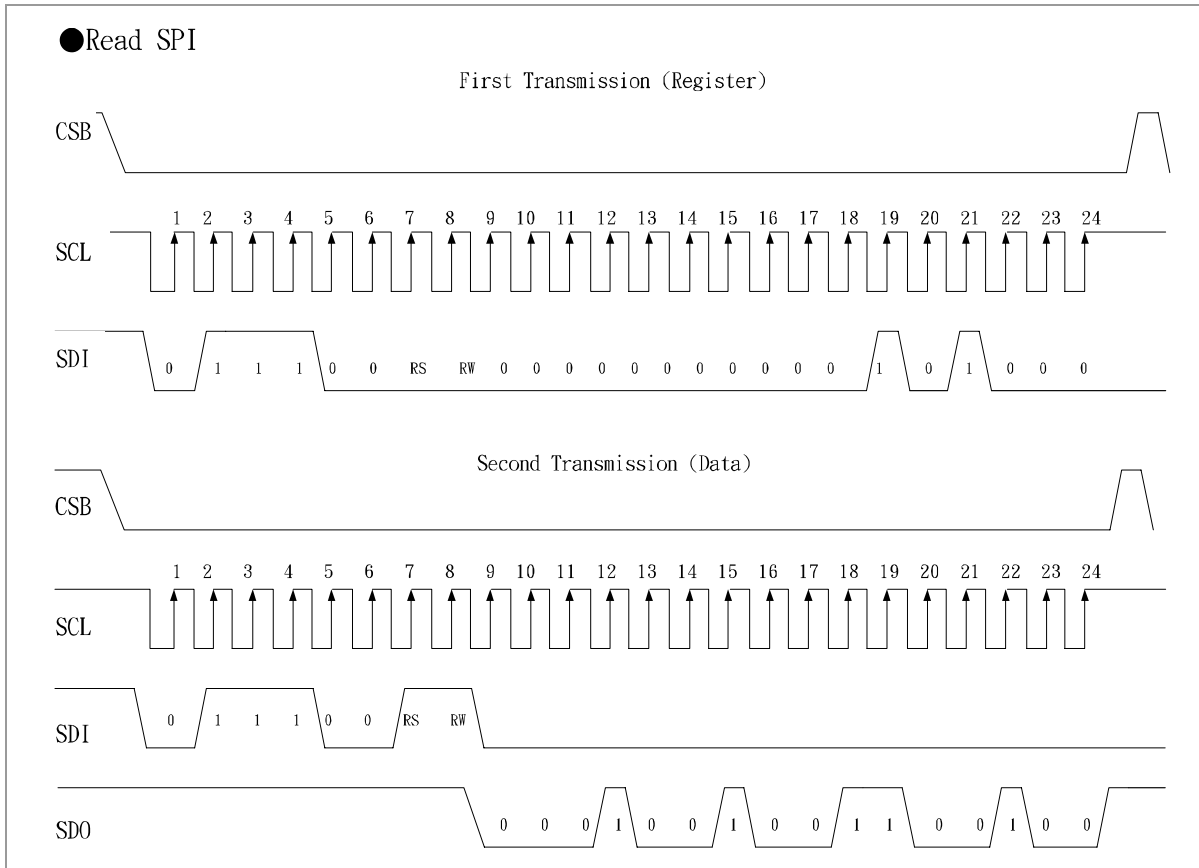

Note: The example Read "0x1264h" from register R28h.

11.5 AC Characteristics

Item	Symbol	Min.	Typ.	Max.	Unit	
DOTCLK Frequency	fDOTCLK	-	6.5	10	MHz	
DOTCLK Period	tDOTCLK	100	154	-	ns	
Horizontal Frequency (Line)	fH	-	14.9	22.35	KHz	
Vertical Frequency (Refresh)	fV	-	60	90	Hz	
Horizontal Back Porch	tHBP	-	68	-	tDOTCLK	
Horizontal Front Porch	tHFP	-	20	-	tDOTCLK	
Horizontal Data Start Point	tHBP	-	68	-	tDOTCLK	
Horizontal Blanking Period	tHBP + tHFP	-	88	-	tDOTCLK	
Horizontal Display Area	HDISP	-	320	-	tDOTCLK	
Horizontal Cycle	Hcycle	-	408	450	tDOTCLK	
Vertical Back Porch	tVBP	-	18	-	Lines	
Vertical Front Porch	tVFP	-	4	-	Lines	
Vertical Data Start Point	tVBP	-	18	-	Lines	
Vertical Blanking Period	tVBP + tVFP	-	22	-	Lines	
Vertical Display Area	NTSC	VDISP	-	240	-	Lines
	PAL			280(PALM=0)		
				288(PALM=1)		
Vertical Cycle	NTSC	Vcycle	-	262	350	Lines
	PAL			313		

11.6 Timing in Parallel RGB (24 bit SYNC Mode)

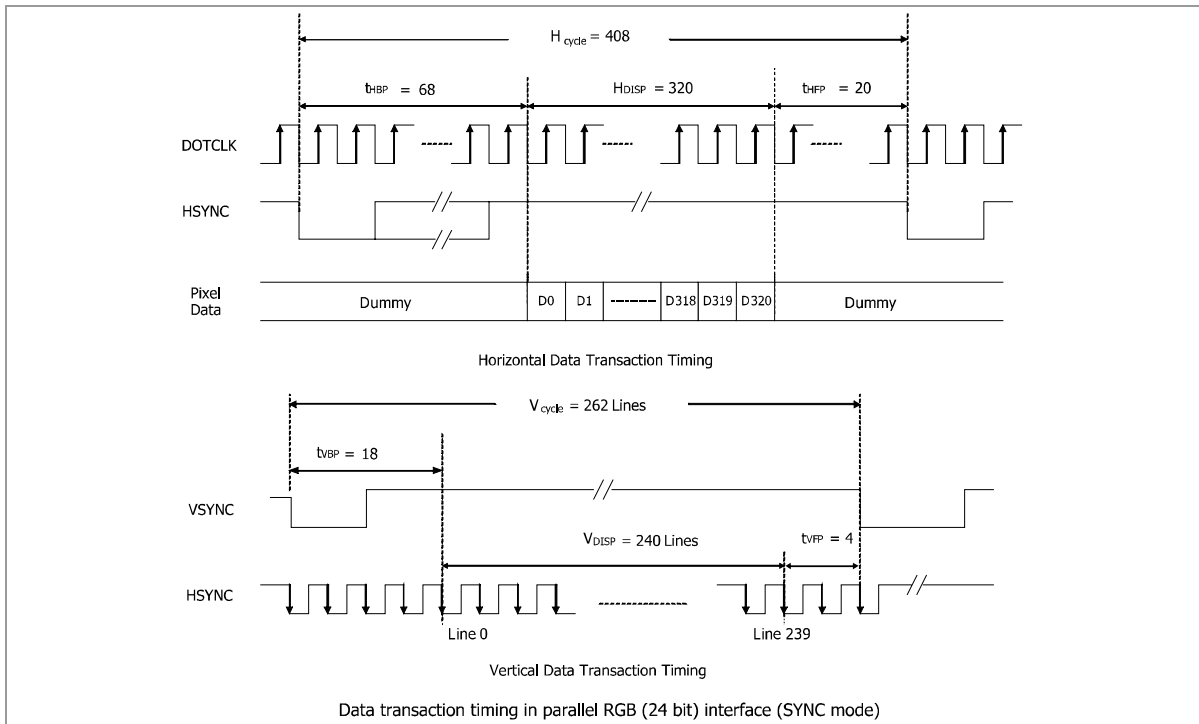

11.7 Timing in Parallel RGB (24 bit DE Mode)

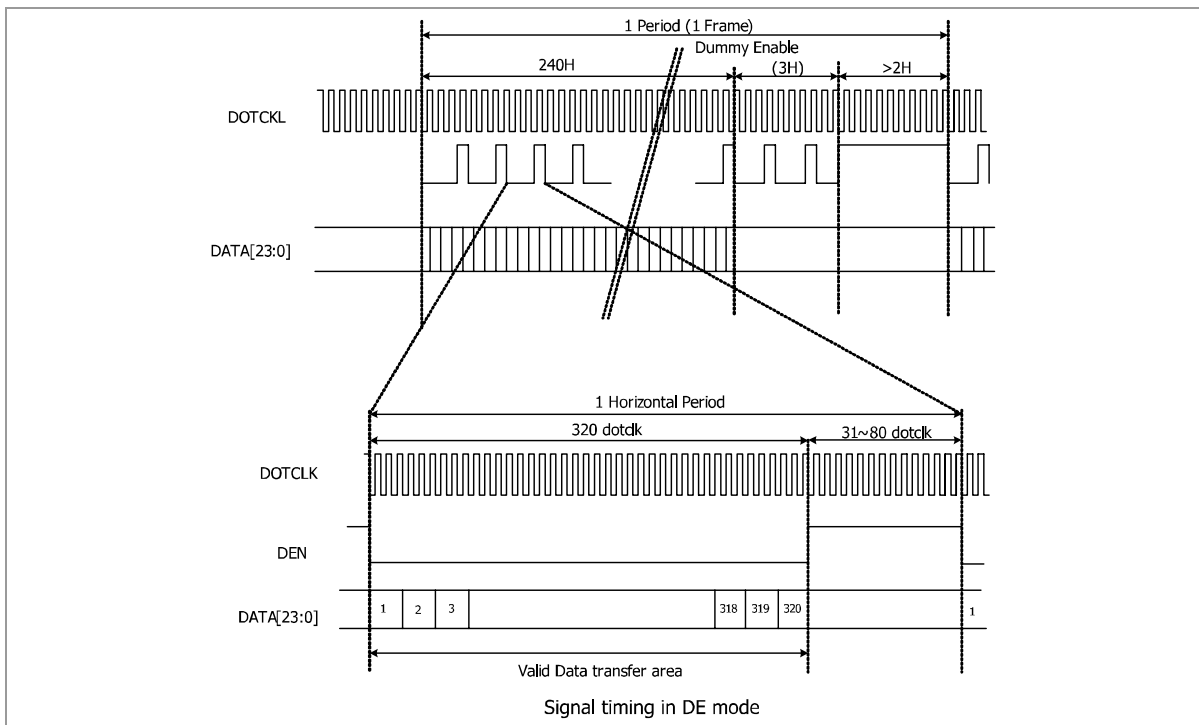

12. Reliability Condition for LCD

No change on display and in operation under the following test condition.

Condition: Unless otherwise specified, tests will be conducted under the following condition.

Temperature: 20±5°C.

Humidity: 65±5%RH.

Tests will be not conducted under functioning state.

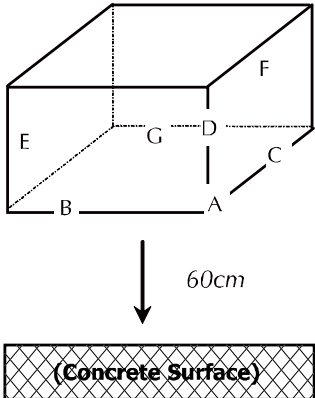
No.	Parameter	Condition	Notes
1	High Temperature Operating	60°C±2°C, 240hrs (Operation state).	-
2	Low Temperature Operating	-10°C±2°C, 240hrs (Operation state).	-
3	High Temperature Storage	70°C±2°C, 240hrs.	-
4	Low Temperature Storage	-20°C±2°C, 240hrs.	-
5	High Temperature and High Humidity Operation Test	60°C±2°C, 90%, 240hrs.	-
6	Vibration Test	Total fixed amplitude: 1.5mm. Vibration Frequency: 10~55Hz. One cycle 60 seconds to 3 direction of X, Y, Z each 15 minutes.	-
7.	Drop Test	To be measured after dropping from 60cm high on the concrete surface in packing state. 	-

13. Incoming Inspection Standards

13.1 Inspection and Environment Conditions

13.1.1 Inspection Conditions:

- (1) Inspection Distance: 35 cm±5cm
- (2) View Angle : Light-on Inspection Angle : ±5°
Cosmetic Inspection Angle : ±45°

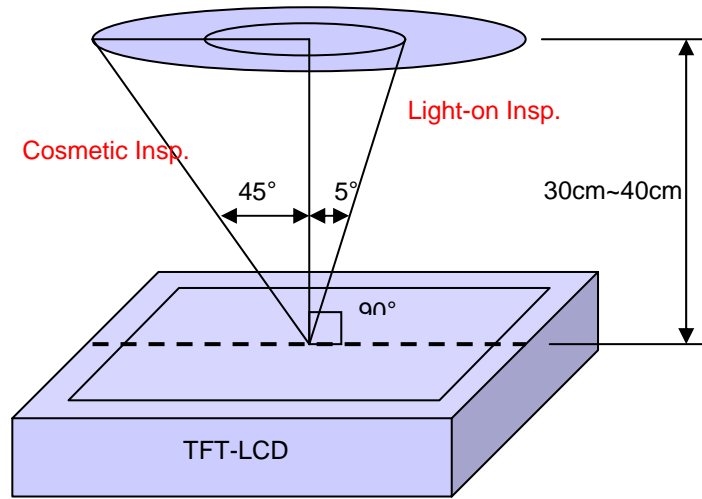

(perpendicular to LCD panel surface)

13.1.2 Environment Conditions:

Ambient Temperature		23°C±5°C
Ambient Humidity		55±10%RH
Ambient Illumination	Cosmetic Inspection	more than 600 Lux
	Functional Inspection	300~500 Lux

13.1.3 Sampling Conditions:

- (1) Lot Size: Quantity of shipment lot per model
- (2) Sampling Method:

Sampling Plan		MIL-STD-105E
		Normal Inspection, Single Sampling
		Level II
AQL	Major Defect	1.0%
	Minor Defect	1.5%

- (3) The classification of Major(MA) and Minor(MI) defects is shown as 3. Inspection Criteria.

13.1.4 Inspection Criteria

13.1.4.1 Cosmetic Inspection(Panel):

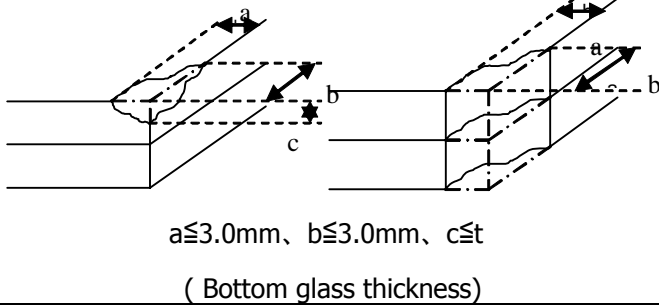
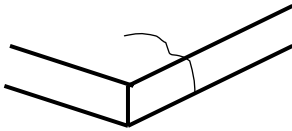
Item	Judgment Criteria	Classification
Chipping on Panel	 <p>$a \leq 3.0\text{mm}$, $b \leq 3.0\text{mm}$, $c \leq t$ (Bottom glass thickness)</p>	MA
Scratch on Panel *Note-2	<p>$W \leq 0.05\text{mm}$ or $L < 5\text{mm}$: Ignored</p> <p>$0.05\text{mm} < W \leq 0.1\text{mm}$ and $L \leq 5\text{mm}$: $N \leq 5$</p> <p>$W > 0.1\text{mm}$ or $L > 5\text{mm}$: Not allowed</p>	MI
Bubble or Dent on Panel *Note-3	<p>$D \leq 0.2\text{mm}$: Ignored</p> <p>$0.2\text{mm} < D \leq 0.3\text{mm}$: $N \leq 5$</p> <p>$D > 0.3\text{mm}$: Not allowed</p>	MI
Panel Crack	 <p>Not Allowed crack</p>	MA
Bezel Deformation	Obvious deformation is not allowed.	MI
Bezel Oxidation	Not allowed if it rusts continuously over 1 cm (It is out of warranty with rusted tin plate)	MI
Bezel Scratch	$L \ 20\text{mm}$, $W \ 0.2$, $N \ 3$	MI
Metal Squash Dent /Flange(Front Side)	$D(W) \ 1, L \ 3, N \ 3;$	MI
B/L High Voltage Wire Denudation	Not allowed	MA
Polarizer flaw or leak out resin	Defect is defined as the active area.	MI
Outline Dimension	Must in Spec, refer to related product spec.	MI

13.1.4.2 Functional Inspection:

Item	Judgment Criteria			Classification
	Area(Note1)	I	O	
Point Defect	Bright dot	Random	2	
		2 dots adjacent	0	0
		3 dots adjacent or more	0	0
	Dark dot	Random	3	
		2 dots adjacent	0	
		3 dots adjacent or more	0	0
	Total Dot Defect		5	
	Distance	Distance between Bright and Bright dot	L 5mm	
		Distance between Bright and Dark dot	L 5mm	
		Distance between Dark dot	L 5mm	
(1) It is defined as Point Defect if defect area > 0.5dot (2) It is ignored if defect area ≤ 0.5dot (3) Weak point defect will be defined as Bright Dot if it can be observed through ND filter 5%(Full Screen Black Inspection)				
Line Defect	Obvious vertical or horizontal line defect is not allowed.			MA
Mura	Not allowed if it can be observed through ND Filter 5 %			MI
Foreign Material in spot shape *Note-3	D ≤ 0.2mm: Ignored 0.2mm < D ≤ 0.5mm: N ≤ 8 D > 0.5mm: Not allowed			MI
Foreign Material in line or spiral shape *Note-4	W ≤ 0.05mm or L ≤ 5mm: Ignored 0.05mm < W ≤ 0.2mm and L 1.0mm ≤ 5mm: N ≤ 8 W > 0.2mm or L > 5mm: Not allowed			MI
Display Function Abnormal	No Malfunction can be allowed			MA

Note-1 : I/O Area Definition

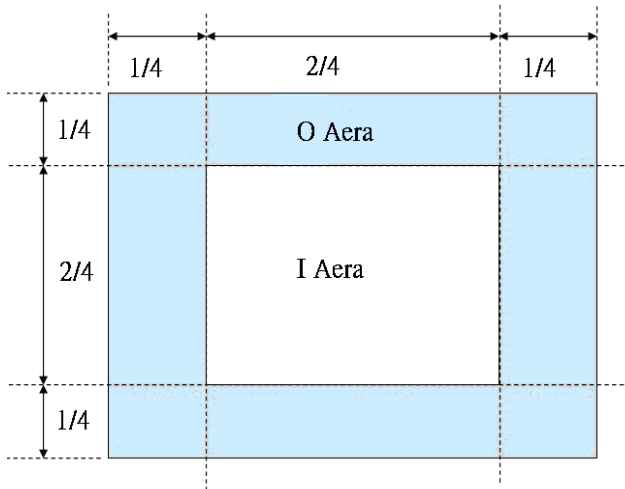

Note-2 : Polarizer Scratch

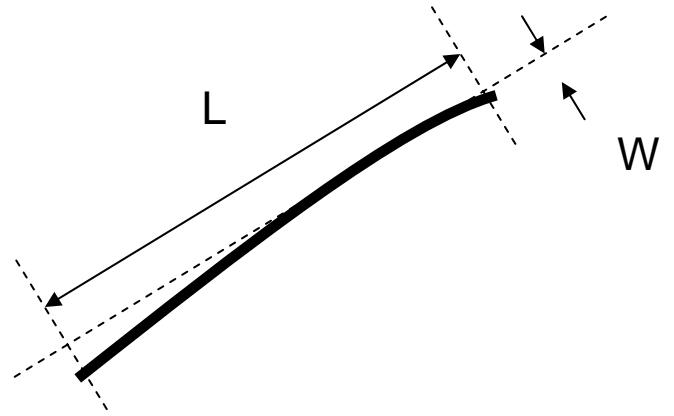

Note-3 : Spot Foreign Material
($W \geq L / 4$)

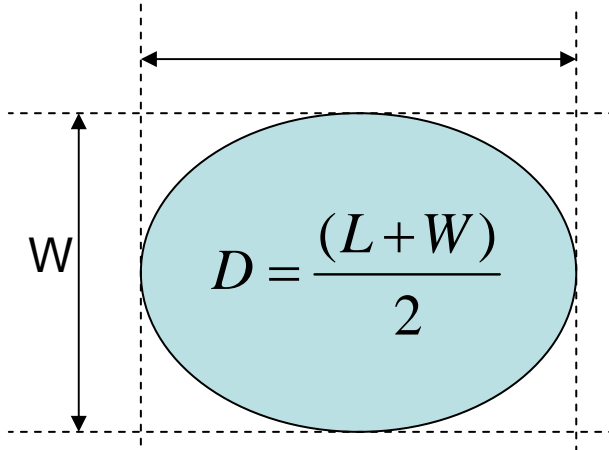

Note-4 : Line or Spiral Foreign Material
($W < L / 4$)

