

DISPLAY Elektronik GmbH

DATA SHEET

LCD MODULE

DEM 16218 SGH

Product Specification

Version: 2

22.09.2017

GENERAL SPECIFICATION

MODULE NO. :

DEM 16218 SGH

CUSTOMER P/N:

Version No.	Change Description	Date
0	Original Version	07.04.2003
1	CHANGE LCD DRIVER (SPLC783A-001A)	21.10.2008
1.1.0	CHANGE LCD DRIVER (ST7066U-0A)	28.06.2017
1.1.1	CORRECT DRAWING	03.07.2017
2	ADD PCB DRAWING	22.09.2017

PREPARED BY: WH

DATE: 22.09.2017

APPROVED BY: MH

DATE: 22.09.2017

CONTENTS

1. FUNCTIONS & FEATURES2

2. MECHANICAL SPECIFICATIONS.....2

3. EXTERNAL DIMENSIONS3

4. BLOCK DIAGRAM.....4

5. PIN ASSIGNMENT.....4

6. THE MODULE NO. IS PRINTED ON THE PCB.....5

7. DISPLAY DATA RAM (DDRAM)6

8. MAXIMUM ABSOLUTE POWER RATINGS6

9. DC CHARACTERISTICS.....6

10. AC CHARACTERISTICS.....7

11. STANDARD CHARACTER PATTERN (ST7066U-0A).....9

12. INSTRUCTION TABLE.....10

13. RESET FUNCTION.....11

14. THE MODULE ACCEPT QUALITY LEVEL (AQL).....13

15. RELIABILITY TEST13

16. QUALITY DESCRIPTION.....14

17. LCD MODULES HANDLING PRECAUTIONS.....15

18. OTHERS15

1. FUNCTIONS & FEATURES

MODULE NAME	LCD TYPE
DEM 16218 SGH	STN Grey Reflective Positive Mode

- Viewing Direction : 6 O'clock
- Driving Scheme : 1/16 Duty Cycle, 1/5 Bias
- Power Supply Voltage : 5.0 Volt (typ.)
- VLCD : 4.5 Volt (typ.)
- Display contents : 16 Characters x 2 line
- Internal Memory : CGROM (13200bits)
: CGRAM (64 x 8bits)
: DDRAM (80 x 8 bits for Digits)
- CGROM : CGROM of the ST7066U-0A
- Interface : Easy Interface with a 4-bit or 8-bit MPU

2. MECHANICAL SPECIFICATIONS

- Character Pitch : 2.85 x 6.25 mm
- Character Size : 2.45 x 5.55 mm
- Character Font : 5 x 8 dots
- Dot Size : 0.45 x 0.65 mm
- Dot Pitch : 0.50 x 0.70 mm

3. EXTERNAL DIMENSIONS

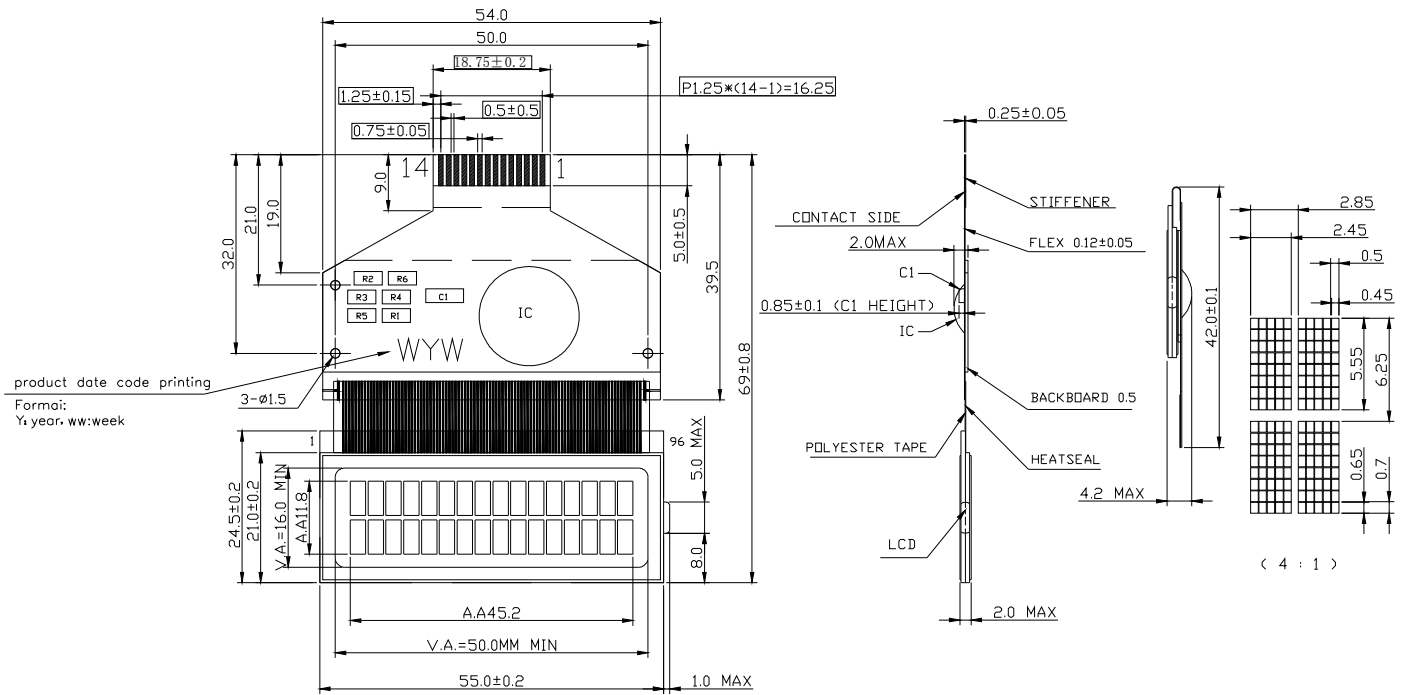

UNSPECIFIED TOLERANCE IS ±0.3
THE MATERIAL IS LEAD-FREE.

4. BLOCK DIAGRAM

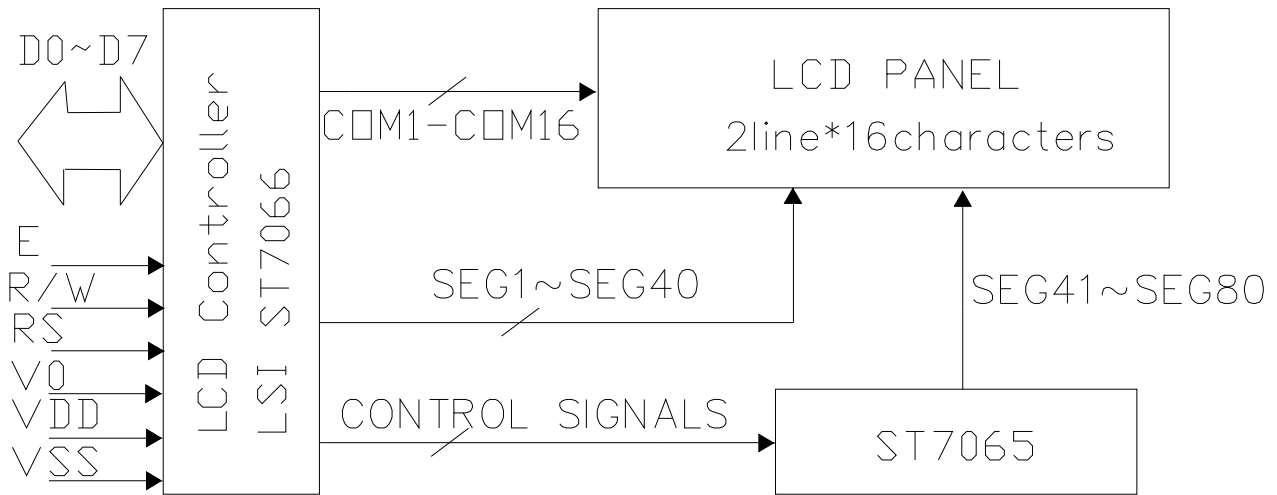

5. PIN ASSIGNMENT

Pin No.	Symbol	Function
1	VSS	Ground terminal of module
2	VDD	Supply terminal of module 5.0 V(typ.)
3	V0	Power Supply for Liquid crystal Drive
4	RS	Register select RS = 0...Instruction register RS = 1...Data register
5	R/W	Read /Write R/W = 1...Read R/W = 0... Write
6	E	Read/Write Enable Signal
7	DB0	Bi-directional data bus, data transfer is performed once, thru DB0 to DB7, in the case of interface data. Length is 8-bits; and twice, thru DB4 to DB7 in the case of interface data length is 4-bits. Upper four bits first then lower four bits.
8	DB1	
9	DB2	
10	DB3	
11	DB4	
12	DB5	
13	DB6	
14	DB7	

6. THE MODULE NO. IS PRINTED ON THE PCB

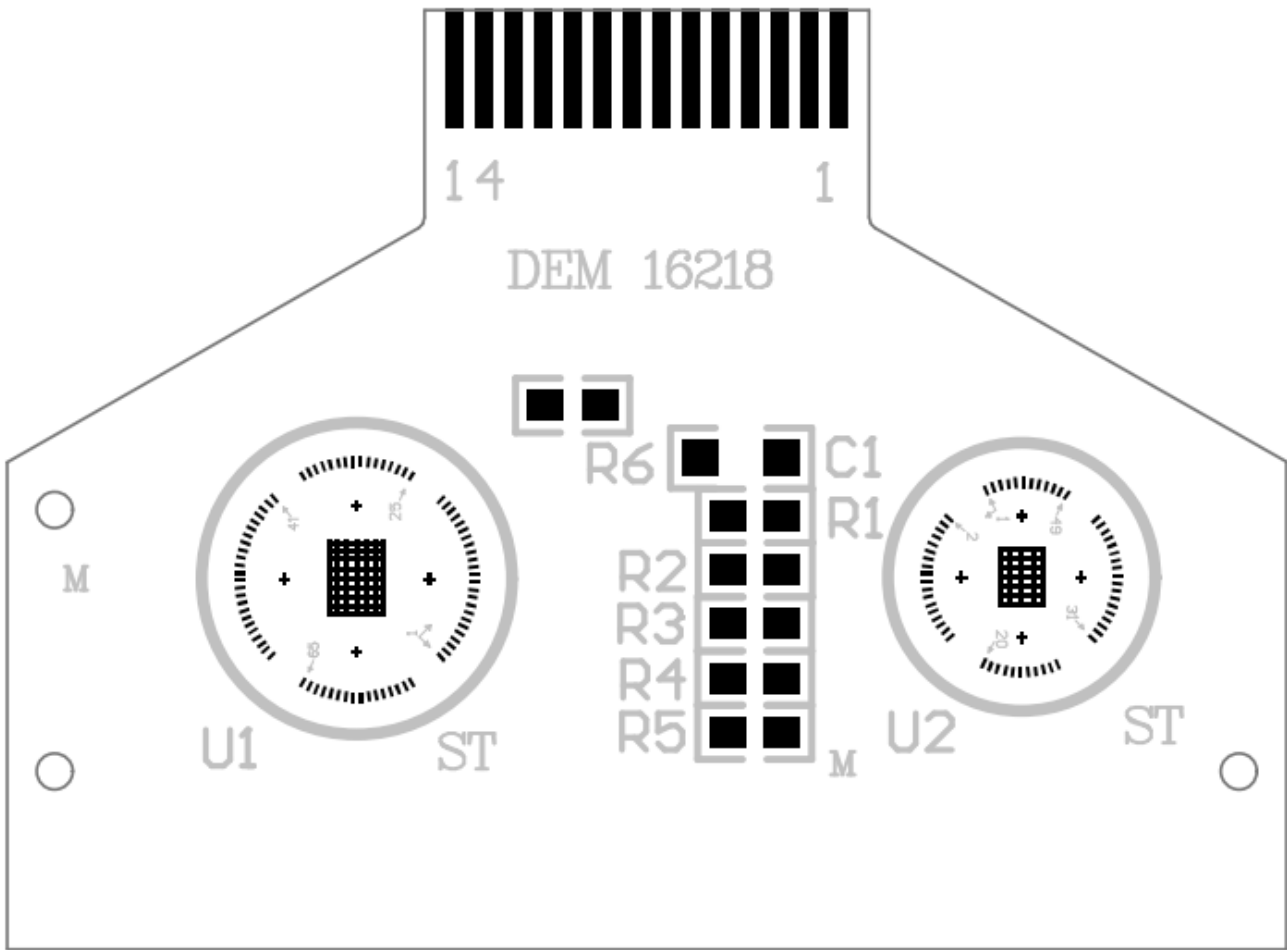

7. DISPLAY DATA RAM (DDRAM)

	1	2	3	4	5	6	7	8	9	10	11	12	13	14	15	16	←DISPLAY POSITION
FIRST LINE	00	01	02	03	04	05	06	07	08	09	0A	0B	0C	0D	0E	0F	←DDRAM ADDRESS
SECOND LINE	40	41	42	43	44	45	46	47	48	49	4A	4B	4C	4D	4E	4F	

8. MAXIMUM ABSOLUTE POWER RATINGS

Item	Symbol	Standard value	Unit
Power Supply Voltage(1)	V _{DD}	-0.3~+7.0	V
Power Supply Voltage(2)	V _{LCD}	V _{DD} -10.0~V _{DD} +0.3	V
Input Voltage	V _{IN}	-0.3~V _{DD} +0.3	V
Operating Temperature	Topr	-20 ~ +70	°C
Storage Temperature	Tstg	-25 ~ +75	°C

9. DC CHARACTERISTICS

Item	Symbol	Standard Value			Test Condition	Unit
		MIN	TYP	MAX		
Operating Voltage	V _{DD}	4.7	5.0	5.3	-----	V
LCD Driving Voltage	V _{LCD}	4.2	4.5	4.8	V _{DD} -V ₀	V
Supply Current	I _{DD}	----	0.9	1.35	-----	mA

***Note:** FOSC = 270 KHz, VDD = 5.0V, pin E = .L, RS, RW, DB0 - DB7 are open, all outputs are no loads.

10. AC CHARACTERISTICS

10-1 Write Mode

(VDD=5.0V, Ta= -10°C ~ +60°C)

Characteristic	Symbol	Min	Type	Max	Unit	Test PIN
Enable Cycle Time	t_c	1200	---	---	ns	E
Enable Pulse Time	T_{PW}	140	---	---	ns	E
Enable Rise/Fall Time	T_R, T_F	---	---	25	ns	E
Address Set-up Time	T_{AS}	0	---	---	ns	RW,RS,E
Address Hold Time	T_{AH}	10	---	---	ns	RW,RS,E
Data Set-up Time	T_{DSW}	40	---	---	ns	DB0~DB7
Data Hold Time	T_H	10	---	---	ns	DB0~DB7

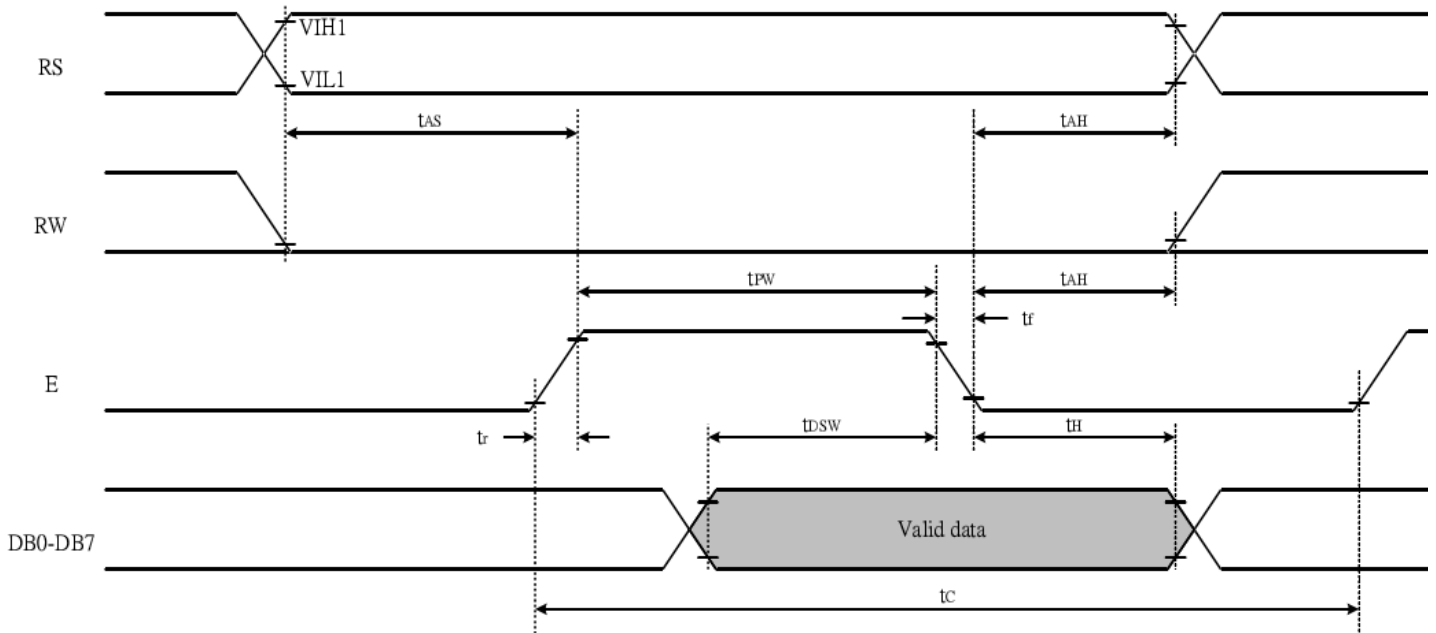

10-2 Read Mode

(VDD=5.0V, Ta=-10°C ~ +60°C)

Characteristic	Symbol	Min	Type	Max	Unit	Test PIN
Enable Cycle Time	t_c	1200	---	---	ns	E
Enable Pulse Time	T_{PW}	140	---	---	ns	E
Enable Rise/Fall Time	T_R, T_F	---	---	25	ns	E
Address Set-up Time	T_{AS}	0	---	---	ns	RW,RS,E
Address Hold Time	T_{AH}	10	---	---	ns	RW,RS,E
Data Set-up Time	T_{DDR}	---	---	100	ns	DB0~DB7
Data Hold Time	T_H	10	---	---	ns	DB0~DB7

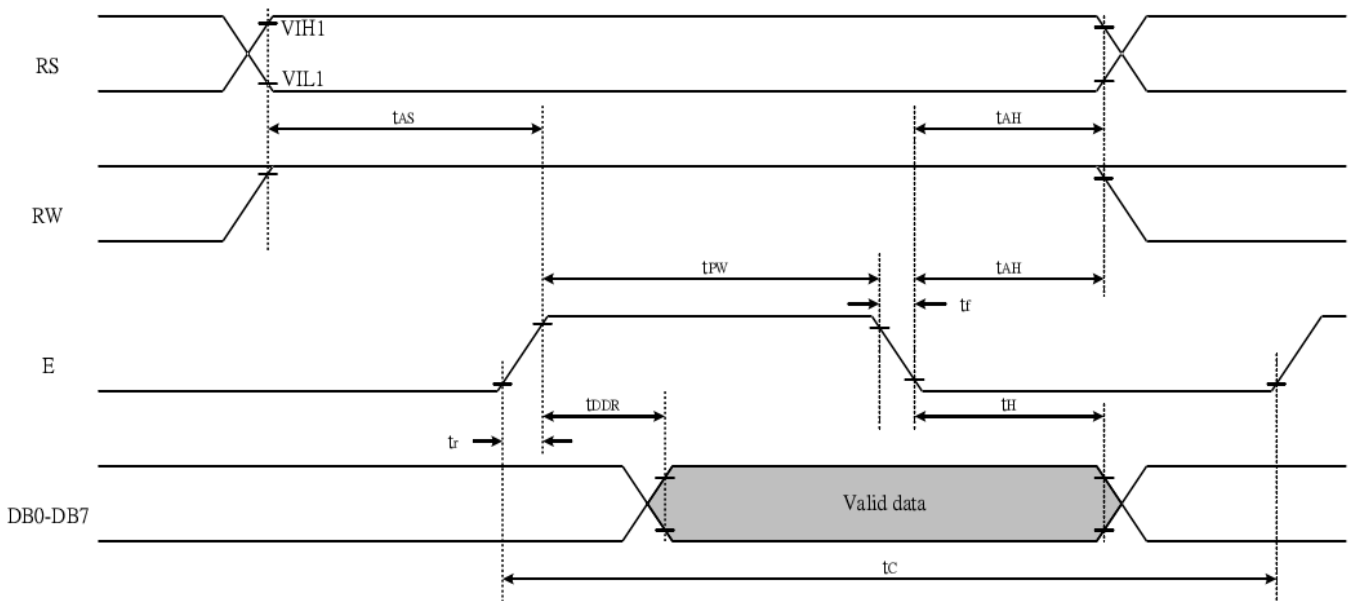

11. STANDARD CHARACTER PATTERN (ST7066U-0A)

NO.7066-0A

b7-b4 b3-b0	0000	0001	0010	0011	0100	0101	0110	0111	1000	1001	1010	1011	1100	1101	1110	1111
0000	CG RAM (1)			0	@	P	\	F				一	9	3	8	P
0001	(2)		!	1	A	Q	a	4			=	F	7	6	8	q
0010	(3)		"	2	B	R	b	r			「	イ	ウ	×	p	0
0011	(4)		#	3	C	S	c	s			」	ウ	7	E	e	∞
0100	(5)		\$	4	D	T	d	t			「	E	T	ト	W	a
0101	(6)		%	5	E	U	e	u			・	オ	★	1	0	0
0110	(7)		&	6	F	V	f	v			ヲ	カ	ニ	ヨ	p	Σ
0111	(8)		*	7	G	W	g	w			ヲ	チ	又	ウ	g	g
1000	(1)		<	8	H	X	h	x			「	ウ	家	U	Σ	Σ
1001	(2)		>	9	I	Y	i	y			ウ	ウ	人	0	ウ	U
1010	(3)		*	#	J	Z	j	z			E	コ	0	V	J	F
1011	(4)		+	;	K	C	k	c			★	ウ	E	0	∞	ア
1100	(5)		・	<	L	#	l	l			ト	ヨ	ウ	ウ	Φ	ア
1101	(6)		—	=	M	∧	m	>			ユ	ズ	∞	ウ	ト	÷
1110	(7)		・	>	N	∧	n	*			ユ	E	ト	∞	∞	
1111	(8)		/	?	O	_	o	*			ウ	ウ	又	∞	0	

12. INSTRUCTION TABLE

Command	RS	R/W	DB7	DB6	DB5	DB4	DB3	DB2	DB1	DB0	Execution time (fosc=270KHz)	Remark
Clear Display	0	0	0	0	0	0	0	0	0	1	1.52ms	Write"20H" to DDRAM. And set DDRAM address to "00H" from AC
Return home	0	0	0	0	0	0	0	0	1	x	1.52ms	Set DDRAM address to "00H" from AC and return cursor to its original position if shifted. The contents of DDRAM are not changed.
Entry mode Set	0	0	0	0	0	0	0	1	I/D	S	37us	Sets cursor move direction and specifies display shift. These operations are performed during data write and read.
Display on/off control	0	0	0	0	0	0	1	D	C	B	37us	D=1: entire display on C=1: cursor on B=1: cursor position on
Cursor or Display Shift	0	0	0	0	0	1	S/C	R/L	x	x	37us	Set cursor moving and display shift control bit, and the direction, without changing DDRAM data.
function Set	0	0	0	0	1	DL	N	F	x	x	37us	DL: interface data is 8/4 bits N: number of line is 2/1 F: font size is 5x11/5x8
Set CGRAM address	0	0	0	1	AC5	AC4	AC3	AC2	AC1	AC0	37us	Set CGRAM address in address counter
Set DDRAM address	0	0	1	AC6	AC5	AC4	AC3	AC2	AC1	AC0	37us	Set DDRAM address in address counter
Read busy flag& address	0	1	BF	AC6	AC5	AC4	AC3	AC2	AC1	AC0	0us	Whether during internal operation or not can be known by reading BF. The contents of address counter can also be read.
Write data to RAM	1	0	D7	D6	D5	D4	D3	D2	D1	D0	37us	Write data into internal RAM (DDRAM/CGRAM)
Read data from RAM	1	1	D7	D6	D5	D4	D3	D2	D1	D0	37us	Read data from internal RAM (DDRAM / CGRAM)

Note:

Be sure the ST7066U is not in the busy state (BF=00 before sending an instruction from the MPU to the ST7066U. If an instruction is sent without checking the busy flag, the time between the first instruction and next instruction will take much longer than the instruction time itself. Refer to instruction table for the list of each instruction execution time.

13. RESET FUNCTION

- 8-bit Interface ($f_{osc} = 270\text{KHz}$)

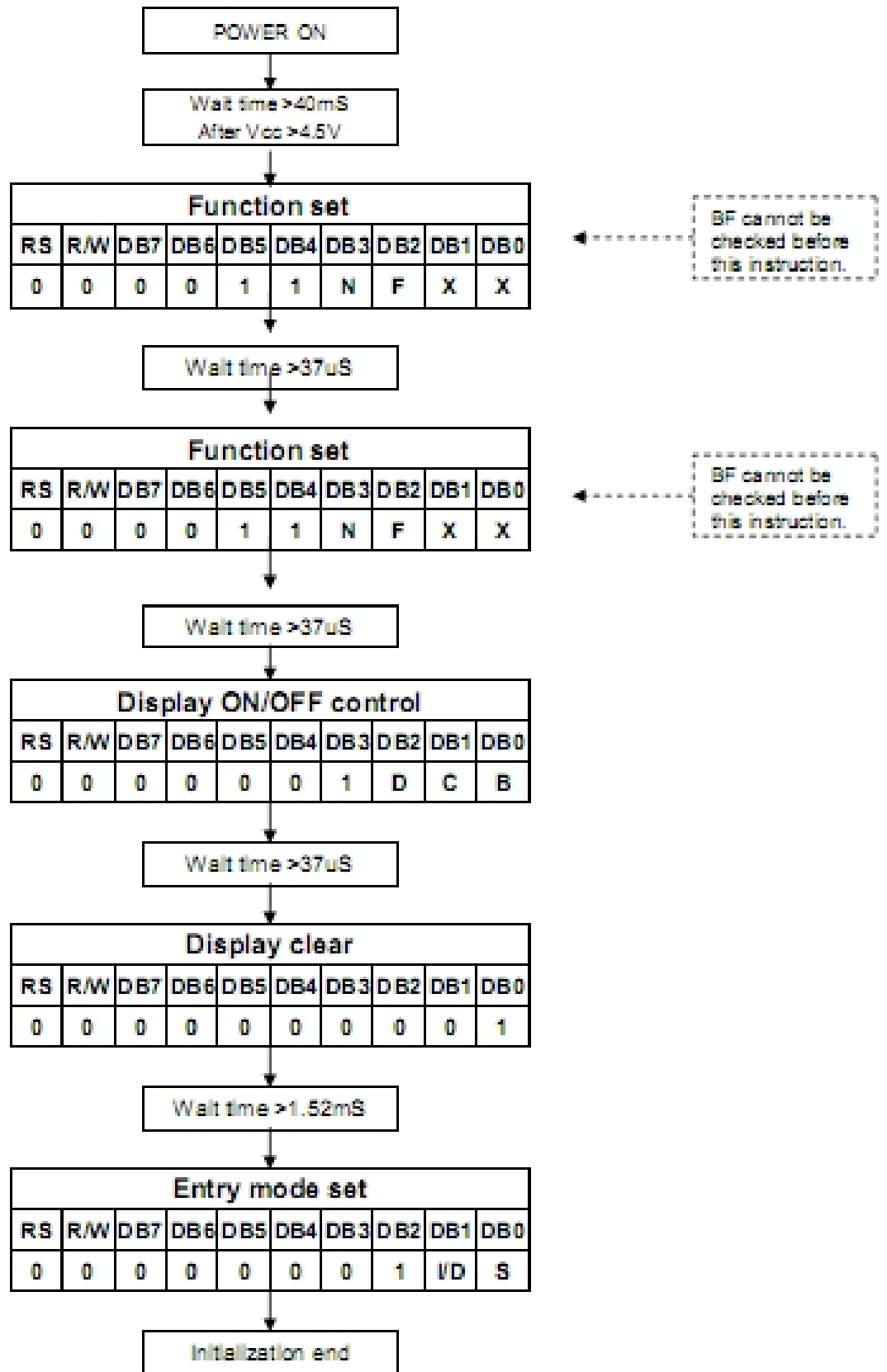

● 4-bit Interface (fosc=270KHz)

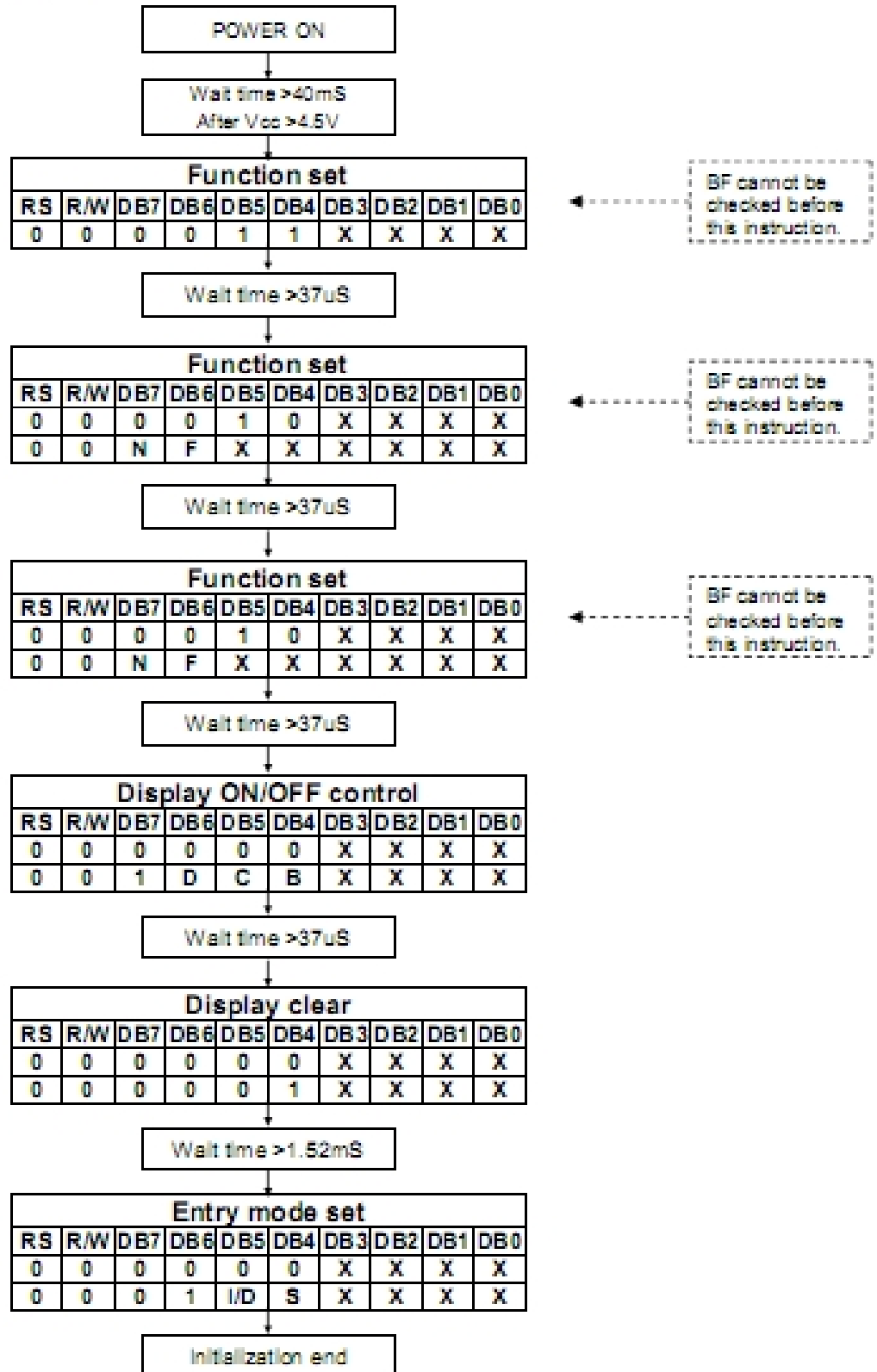

14. THE MODULE ACCEPT QUALITY LEVEL (AQL)

14.1. AQL standard value: Critical defect =0.1, Major defect=0.65; Minor defect =2.5.

14.2. Curtailed Inspection Scheme

Type	Batch Qty	inspection Qty	AQL value	pass	Reject
module product	350PCS< 1000PCS	125pcs	0.1	0	1
			0.65	2	3
			2.5	7	8
	200< 350PCS	80pcs	0.1	0	1
			0.65	1	2
			2.5	5	6
	<200PCS	32pcs	0.1	0	1
			0.65	0	1
			2.5	4	5
Module sample	<200PCS	All inspected	/	/	The sample will be reject when the fateful defect>2pcs or main defect>5pcs.
	>200PCS	125pcs			

- Notes: 1). Batch QTY is the product amount that Product department ship to QA department.
 2). All of product will be inspected if the batch QTY less than inspected QTY.
 3). Each batch standard QTY are 500pcs.

15. RELIABILITY TEST

Operating life time: 50,000 hours (at room temperature without direct irradiation of sunlight)

Reliability characteristics shall meet following requirements.

Tests Item	Condition
High temperature storage	+75°C x 96HRS (Without Polarizer)
Low temperature storage	-25°C x 4HRS
High temperature operation	+70°C x 96HRS
Low temperature operation	-20°C x 4HRS
High temperature, High humidity	+70°C x 95%RH x 96HRS (Without Polarizer)
Thermal shock	-20°C x 30min → +25°C x 10s → +70°C x 30 min x 5 cycles
Vibration test	Frequency x Swing x Time 40Hz x 4mm x 4hrs
Drop test	Drop height*Times 1.0m * 6times

16. QUALITY DESCRIPTION

DEFECT SPECIFICATION:

Specific type-related items are covered in this sheet.

a: Table for Cosmetic defects
 (Note: nc = not counted).
 Sizes and number of defects
 (Max. Qty)

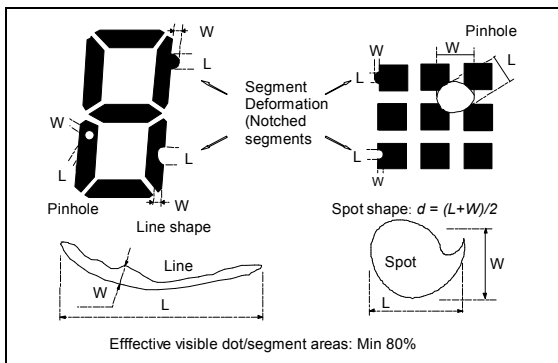

Example

s/ Shapes

b: Glass defects

b1: Glass defects at contact ledge

b2: Glass chipping in other areas shall not be in conflict

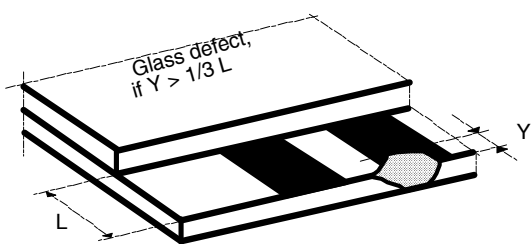

with the product's function.

Defect Type	Max. defect size [μm] d or L W	Max. Quantity.
Black or White Spots	$d \leq 100$	nc
	$100 < d \leq 200$	5
Black or White Lines	--	nc
	$L \leq 5000$ $W \leq 30$	3
	$L \leq 2000$ $W \leq 50$	2
Pinhole	$d \leq 100$	nc
	$100 < d \leq 200$	1/segment
(Total defects)		(5)
Segment Deformation	$W \leq 100$	nc
Bubble (e.g. under pola)	$d \leq 150$	nc
	$200 < d \leq 400$	3
	$400 < d \leq 600$	1

17. LCD MODULES HANDLING PRECAUTIONS

- Please remove the protection foil of polarizer before using.
- The display panel is made of glass. Do not subject it to a mechanical shock by dropping it from a high place, etc.
- If the display panel is damaged and the liquid crystal substance inside it leaks out, do not get any in your mouth. If the substance come into contact with your skin or clothes promptly wash it off using soap and water.
- Do not apply excessive force to the display surface or the adjoining areas since this may cause the color tone to vary.
- The polarizer covering the display surface of the LCD module is soft and easily scratched. Handle this polarize carefully.
- To prevent destruction of the elements by static electricity, be careful to maintain an optimum work environment.
 - Be sure to ground the body when handling the LCD module.
 - Tools required for assembly, such as soldering irons, must be properly grounded.
 - To reduce the amount of static electricity generated, do not conduct assembly and other work under dry conditions.
 - The LCD module is coated with a film to protect the display surface. Exercise care when peeling off this protective film since static electricity may be generated.
- Storage precautions
When storing the LCD modules, avoid exposure to direct sunlight or to the light of fluorescent lamps. Keep the modules in bags designed to prevent static electricity charging under low temperature / normal humidity conditions (avoid high temperature / high humidity and low temperatures below 0°C). Whenever possible, the LCD modules should be stored in the same conditions in which they were shipped from our company.

18. OTHERS

- Liquid crystals solidify at low temperature (below the storage temperature range) leading to defective orientation of liquid crystal or the generation of air bubbles (black or white). Air bubbles may also be generated if the module is subjected to a strong shock at a low temperature.
- If the LCD modules have been operating for a long time showing the same display patterns may remain on the screen as ghost images and a slight contrast irregularity may also appear. Abnormal operating status can be resumed to be normal condition by suspending use for some time. It should be noted that this phenomena does not adversely affect performance reliability.
- To minimize the performance degradation of the LCD modules resulting from caused by static electricity, etc. exercise care to avoid holding the following sections when handling the modules:
 - Exposed area of the printed circuit board
 - Terminal electrode sections.